



Value Leader

Mission

ICC is a manufacturer of structured cabling products, with a focus on meeting the needs of small and medium-sized cabling system Installers. Our goal is to become the preferred and most reliable brand for our Installers.

Value

We are committed to constantly reducing product costs while delivering superior value, enabling our Installers to bid competitively and win more projects.

Standard

Our products conform to the highest industry standards set by FCC®, TIA®, and UL®, and we back them with comprehensive warranty programs. We take pride in that Elite Installers consistently rate our products higher in performance than the big brands.

One

We offer nine product categories to accommodate most end-to-end cabling projects. Installers can consolidate their cabling supplies through one manufacturer with one warranty program.

Distribution

We have hundreds of distribution partners throughout the United States to serve our Installers, and you can find them listed on icc.com/distributor.



Table of Contents

Work Area Outlets

1

Patch Panels and Cross-Connect

19

Racks and Cable Management

29

Residential Enclosures

43

Premise Cables

49

Cords and Cable Assemblies

53

Fiber Optic Systems

59

Cable Raceway

67

Tools and Accessories

71

Part Number Index

75





Small & Mid-Sized Installers

ICC helps small and medium-sized Installers win more projects with tailored solutions.



Non-Spec Projects

ICC specializes in non-spec projects and helps Elite Installers win them over expensive spec brands.



Ease of Installation

ICC's easy-to-install products reduce training time and labor costs.

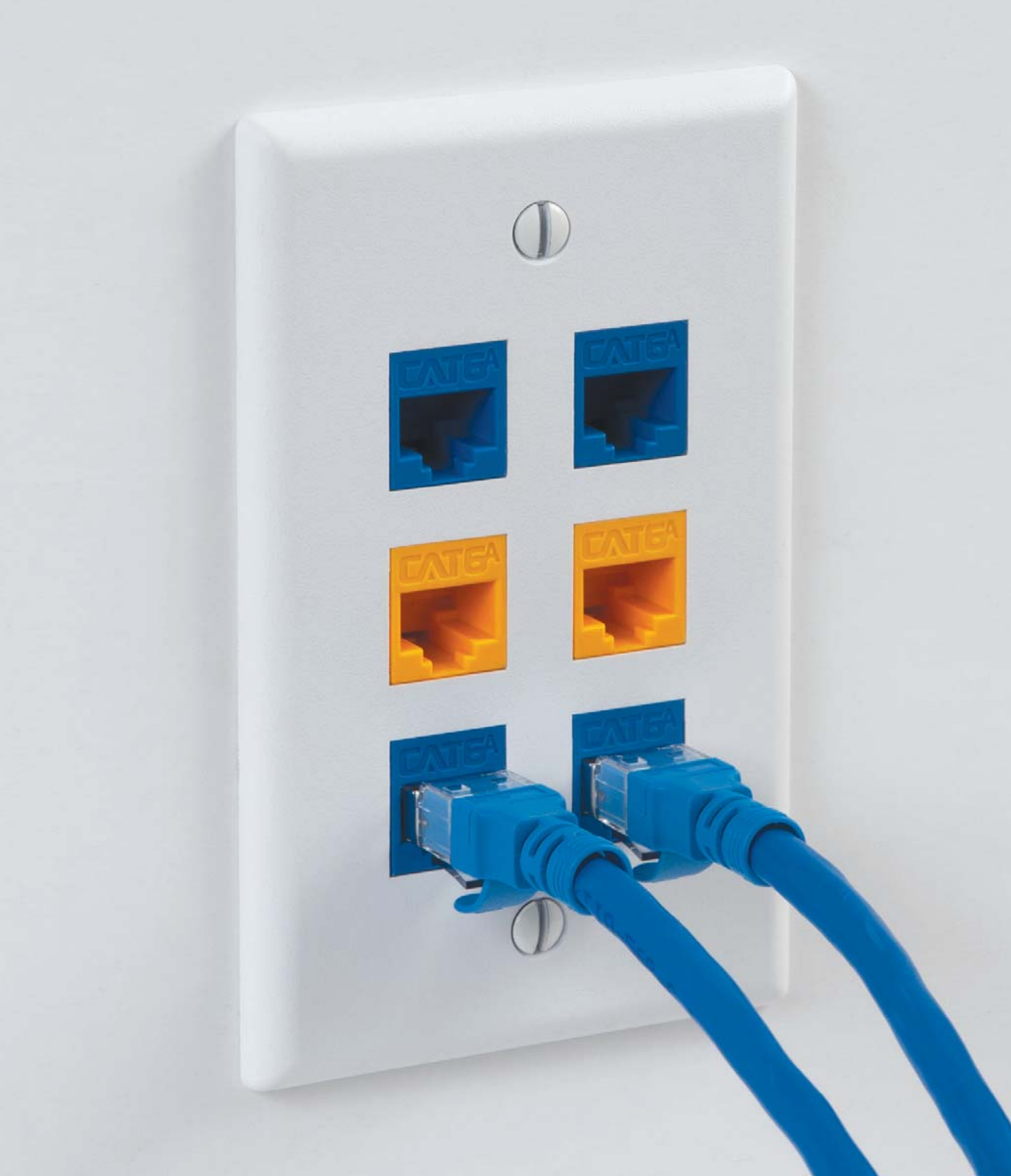

Modular Connectors	2-9
Faceplates	10-13, 16-17
Surface Mount Boxes	14-15
Surface Mount Jacks	15
Mounting Boxes	18
Mobile Patch Boxes	18

High-Density Keystone Connectors



- Rear split-back IDC
- Narrow body for high-density applications

CAT 6	Single	10-Pack	25-Pack	400-Pack	400-Pack w/ JackEasy Tool
Colors (xx)*:	IC1078F6xx*	IC107F6Txx*	IC107F6Cxx*	IC107F6Rxx*	IC107F6Vxx*
WH					
BL					
BK					
OR					
IV					
RD					
YL					
GN					
GY					
AL					
PR					



CAT 5e	Single	10-Pack	25-Pack
Colors (xx)*:	IC1078F5xx*	IC107F5Txx*	IC107F5Cxx*
WH			
BL			
BK			
OR			
IV			
RD			
YL			
GN			
GY			
AL			



Voice UTP	Single	10-Pack	25-Pack
Colors (xx)*:	IC1076F0xx*	IC1076FTxx*	IC1076FCxx*
WH			
BL			
BK			
IV			
GY			
AL			



WORK AREA OUTLETS

High-Density Keystone Connectors



- Rear split-back IDC
- Narrow body for high-density applications

CAT 6A UTP	Single	10-Pack	25-Pack
Colors (xx)*:	IC1078GAxx*	IC107GATxx*	IC107GACxx*
WH			
BL			
BK			
OR			
IV			
RD			
YL			



CAT 6A FTP	Single	10-Pack	25-Pack
Shielded	IC1078S6A0	IC107SATA0	IC107SACA0



Shielded wiring cap suppresses Alien Crosstalk



Enhanced crosstalk cancelation reduces Return Loss



Metal body shields from electromagnetic interference



Metal body rejects noise and unwanted signals

EZ[®] Keystone Connectors



- Rear in-line IDC
- Pair-to-pair wiring

CAT 6	Single	10-Pack	25-Pack	400-Pack	400-Pack w/ JackEasy Tool
Colors (xx)*:	IC1078L6xx*	IC107L6Txx*	IC107L6Cxx*	IC107L6Rxx*	IC107L6Vxx*
WH					
BL					
BK					
OR					
IV					
RD					
YL					
GN					
GY					
AL					
PR					



CAT 5e UTP	Single	10-Pack	25-Pack
Colors (xx)*:	IC1078E5xx*	IC107E5Txx*	IC107E5Cxx*
WH			
BL			
BK			
OR			
IV			
RD			
YL			
GN			
GY			
AL			



Voice UTP	Single	10-Pack	25-Pack
Colors (xx)*:	IC1076V0xx*	IC1076VTxx*	IC1076VCxx*
WH			
BL			
BK			
IV			
GY			
AL			



HD or EZ[®]

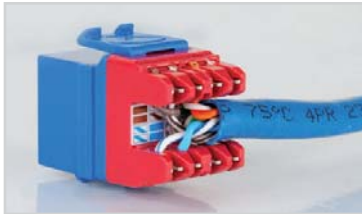

Split-Back IDC
Compact termination

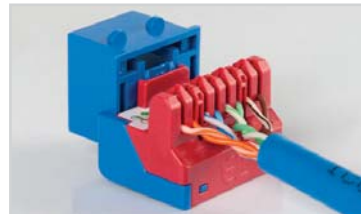

In-Line IDC
Easy pair-to-pair wiring



Slim Body
Increase connectivity
in limited space

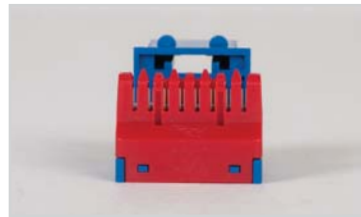

Wide Body
Grip connectors
with comfort



**Maximize
Rack Space**
Up to 48 ports in 1 RMS



**Easy Rack
Installation**
More working space



**Maximize
Outlet Space**
Up to 6 ports in
a decor faceplate



**Easy Outlet
Installation**
Use thumb and fingers



One Tool



For Both

Keystone Couplers



- HD style housing with female-to-female connectors

Description	Single	10-Pack	25-Pack
CAT 6 [A]	IC107CP6xx* 	IC107C6TBK 	IC107C6CBK
CAT 5e [B]	IC107C5Exx* 	IC107C5TBK 	IC107C5CBK
CAT 6A UTP [C]	IC107C6Axx* 	IC107CATBK 	IC107CACBK
CAT 6A FTP Shielded [D]	IC107C6AS1	IC107CATS1	N/A
Voice 6P6C pin 1-6 [E]	IC107C6Sxx* 	N/A	N/A
Voice 6P6C pin 1-1	IC107C6Rxx* 	N/A	N/A

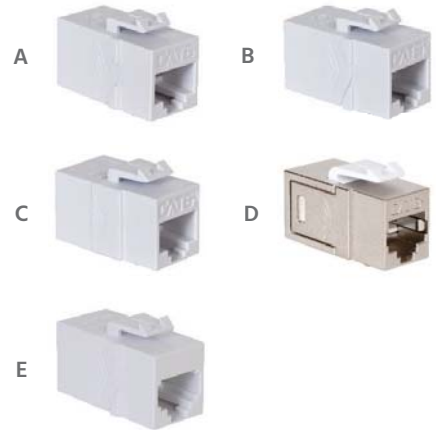

Fiber-Optic Couplers

- HD style housing with female-to-female connectors
- Dust caps are included

Description	Single
LC Duplex, aqua adapter [E]	IC107LCGxx*
LC Duplex, blue adapter	IC107LC2xx*
SC Simplex, blue adapter [F]	IC107SC2xx*
ST Simplex, metal adapter	IC107ST2xx*



Blank Inserts

- HD style housing

Description	10-Pack	100-Pack
Fill-in [G]	IC107BN0xx* 	IC107BNVxx*
Feed-through, 0.30" diameter hole [H]	IC107BN2WH 	N/A



*Colors (xx):

WH (White)	BK (Black)	IV (Ivory)	GY (Gray)	AL (Almond)

F-Type Video Jacks



- HD style housing with female-to-female connectors
- Works with RG-6 and RG-59 coaxial cables



Description	Single	10-Pack	25-Pack
Nickel-plated, 3 GHz [A]	IC107B9Fxx* [Color swatches: WH, BK, IV, GY, AL]	IC1079FTWH	IC107BFDWH
Gold-plated, 3 GHz [B]	IC107B9Gxx* [Color swatches: WH, BK, IV, GY, AL]	N/A	IC107BGDWH
Nickel-plated, 2 GHz	IC107B5Fxx* [Color swatches: WH, BK, IV, GY, AL]	IC1075FTWH	IC107BFCWH
Gold-plated, 2 GHz	IC107B5Gxx* [Color swatches: WH, BK, IV, GY, AL]	N/A	IC107BGCWH
Nickel-plated, 2 GHz, RG-6Q, compression [C]	IC107FQGWH	N/A	N/A

Dual Audio Speaker Connectors

- HD style housing with push buttons

Description	Single
Rear crimp-on [D]	IC107DSCxx* [Color swatches: WH, BK, IV, GY, AL]
Rear buttons [E]	IC107DSBxx* [Color swatches: WH, BK, IV, GY, AL]



Binding Post Audio Speaker Connectors

- HD style housing with gold-plated posts
- Posts work with banana plugs

Description	Single
Rear set-screw connection	IC107PMGxx* [Color swatches: WH, BK, IV, GY, AL]



3.5mm Stereo Audio Speaker Couplers

- HD style housing with 3.5mm jack
- Rear push-pins accept 22~24 AWG UTP wires

Description	Single
Female-to-push-pin	IC107SAPxx* [Color swatches: WH, BK, IV, GY, AL]



*Colors (xx):
 [Color swatches: WH, BK, IV, GY, AL]
 WH (White) BK (Black) IV (Ivory) GY (Gray) AL (Almond)

HDMI Couplers

- HD style housing with female-to-female connectors

Description	Single	10-Pack	25-Pack
Straight [A]	IC107HDMxx* 	IC107HDTWH 	IC107HDCWH
Angled 90° [B]	IC107AHMWH 	N/A	N/A

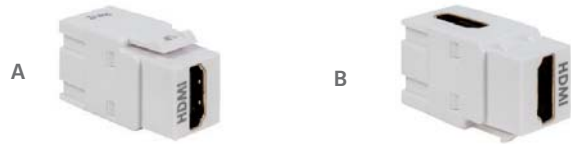

HDMI Décorex™ Inserts

- Works with Décorex faceplates and includes two blank inserts
- Female-to-female connectors

Description	Single
1 HDMI, 2 HD Ports [C]	IC107DH2xx*
2 HDMI, 2 HD Ports [D]	IC107DDHxx*

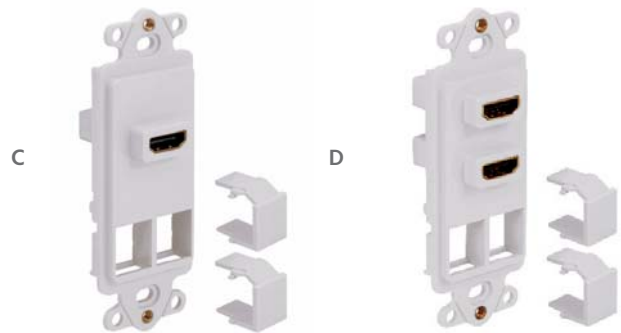

USB Couplers

- HD style housing with female-to-female connectors

Description	Single
90°, A-to-A, USB 3.0 [E]	IC107AUSWH
A-to-A, USB 3.0 [F]	IC107UAAWH
Reversible A-to-B, USB 2.0 [G]	IC107UABWH

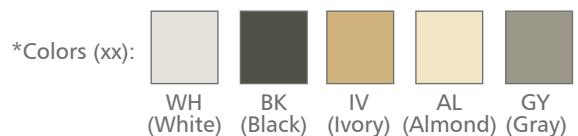

HDMI



Straight-through
Typical maximum operating distance of HDMI cable: 50 feet

90°

Rear

USB 3.0



Straight-through
Typical maximum operating distance of USB 3.0/USB 3.1 cable: 9 feet and 10 inches

90°

Rear

USB 2.0

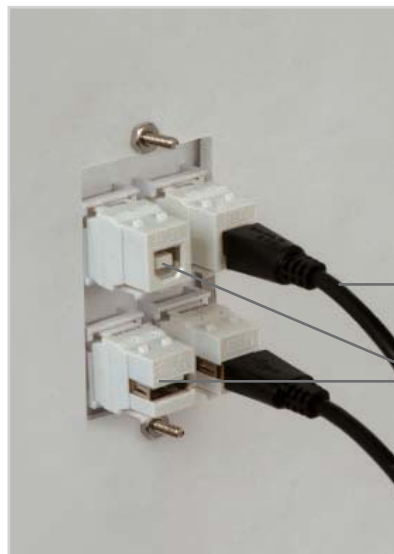

Typical maximum operating distance of USB 2.0 cable: 16 feet and 5 inches

Reversible

Rear

Classic Faceplates

- Durable ABS plastic

Description	Single	10-Pack	25-Pack
Blank, single gang	IC630EB0xx* 	N/A	N/A
1 Port, single gang [A]	IC107F01xx* 	IC107F1Txx* 	IC107F1Cxx*
2 Ports, single gang	IC107F02xx* 	IC107F2Txx* 	IC107F2Cxx*
3 Ports, single gang	IC107F03xx* 	IC107F3Txx* 	IC107F3Cxx*
4 Ports, single gang	IC107F04xx* 	IC107F4Txx* 	IC107F4Cxx*
6 Ports, single gang	IC107F06xx* 	N/A	N/A

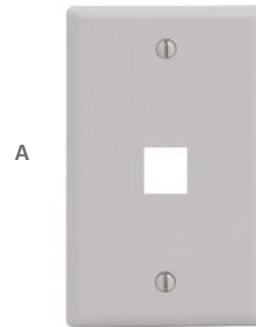

A

Description	Single	25-Pack
Blank, double gang	IC630EBDxx* 	N/A
8 Ports, double gang [B]	IC107FD8xx* 	N/A
12 Ports, double gang	IC107F12xx* 	N/A

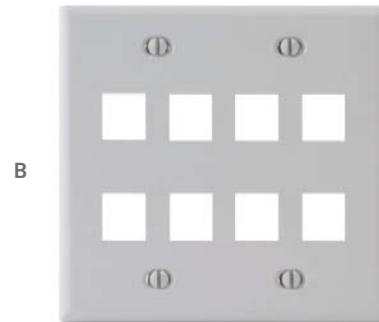

B

Description	Single	25-Pack
12 Ports, triple gang	IC107FT0WH 	N/A

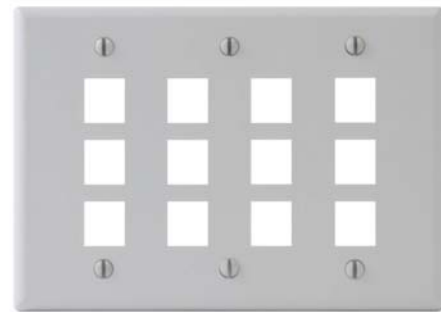

C

Classic Stainless Steel Faceplates

Description	Single
Blank, single gang	IC630EBSSS
1 Port, single gang [C]	IC107SF1SS
2 Ports, single gang	IC107SF2SS
3 Ports, single gang [D]	IC107SF3SS
4 Ports, single gang	IC107SF4SS
6 Ports, single gang	IC107SF6SS
4 Ports, double gang	IC107DF4SS
8 Ports, double gang	IC107DF8SS



C



D

*Colors (xx):

WH (White)	IV (Ivory)	AL (Almond)	BK (Black)	GY (Gray)

Décorex™ Faceplates and Inserts



Faceplate	Single
1 Insert, single gang [A]	IC107DFSxx*
2 Inserts, double gang	IC107DFDxx*
3 Inserts, triple gang [B]	IC107DFTWH
1 Insert, single gang, stainless steel	IC107DFSSS
2 Inserts, double gang, stainless steel [C]	IC107DFDSS



A

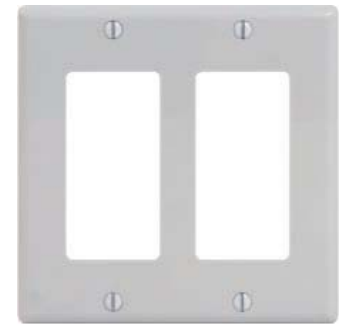

B



C

Insert	Single
Blank, single gang	IC630DIBxx*
1 Port, single gang [D]	IC107DI1xx*
2 Ports, single gang	IC107DI2xx*
3 Ports, single gang [E]	IC107DI3xx*
6 HD Ports, single gang [F]	IC107DI6xx*



D



E



F

Telephone Faceplates with Hanging Standoffs

Description	Single
1 Port, single gang [G]	IC107FFWxx*
1 Port, stainless steel, single gang [H]	IC107FFWSS



G



H

*Colors (xx):
 WH (White)
 IV (Ivory)
 BK (Black)



Classic Faceplates with Station ID

Description	Single	10-Pack
1 Port, single gang	IC107S01xx* 	IC107S1TWH
2 Ports, single gang [A]	IC107S02xx* 	IC107S2TWH
3 Ports, single gang	IC107S03xx* 	N/A
4 Ports, single gang [B]	IC107S04xx* 	N/A
6 Ports, single gang	IC107S06xx* 	N/A

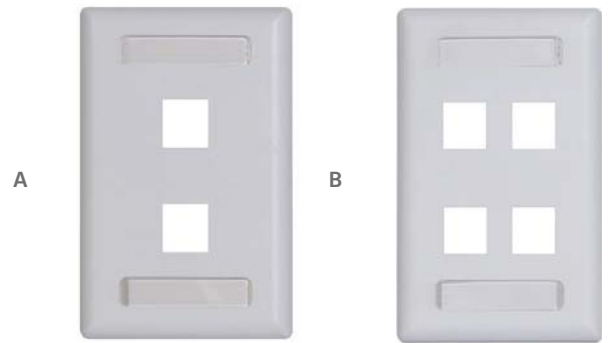

Classic Stainless Steel Faceplates with Station ID

Description	Single
1 Port, single gang	IC107S01SS
2 Ports, single gang [C]	IC107S02SS
3 Ports, single gang	IC107S03SS
4 Ports, single gang	IC107S04SS
6 Ports, single gang	IC107S06SS

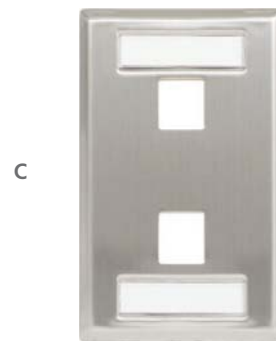

HD Furniture Faceplates

Description	Single
NEMA Opening: 1.83" H x 2.60" W x 0.19" D, 4 HD Ports [D]	IC107FN4xx*
TIA Opening: 1.33" H x 2.60" W x 0.19" D, 4 HD Ports	IC107FT4xx*



Furniture Faceplates

Description	Single
TIA Opening: 1.30" H x 2.56" W x 0.19" D, 3 Ports	IC107FM3xx*

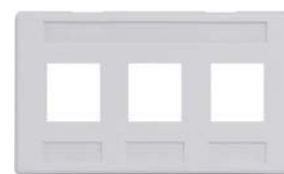

*Colors (xx):

WH (White)	IV (Ivory)	BK (Black)	GY (Gray)

Classic Oversized Faceplates

- 3.12" W x 4.87" H, covers uneven drywall cuts



Description	Single
1 Port, single gang [A]	IC107LF1xx*
2 Ports, single gang	IC107LF2xx*
3 Ports, single gang	IC107LF3xx*
6 Ports, single gang	IC107LF6xx*

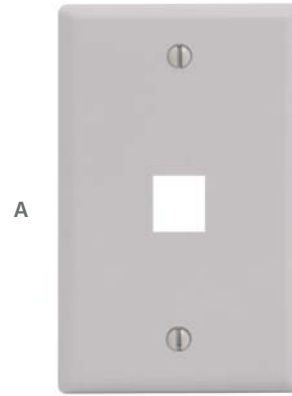

Angled Faceplates

Description	Single
1 Port, single gang	IC107DA1xx*
2 Ports, single gang [B]	IC107DA2xx*
4 Ports, single gang	IC107DA4xx*
4 Ports, 2 flat/2 angled, with station ID, single gang [C]	IC107AS4WH

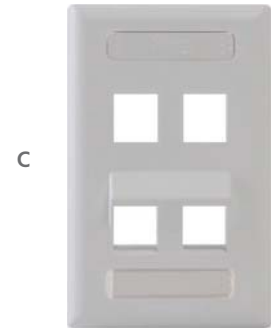
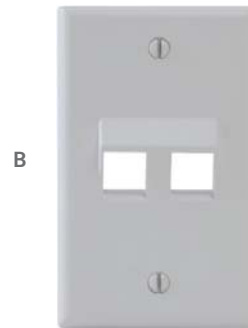

Bulk Nose Faceplates

Description	Single
Opening: 1.25" W x 0.90" D, single gang [D]	IC640BSSxx*
Opening: 2.75" W x 1.15" D, double gang	IC640BDSxx*



Configurable Electrical

Description	Single
2 Ports, Faceplate, single gang [E]	IC106FP2xx*
2 Ports, Insert, single gang	IC107DPIxx*
4 HD Ports, Insert, single gang [F]	IC1074PIxx*

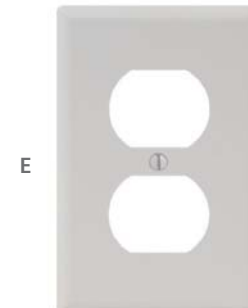

*Colors (xx):
 WH (White) IV (Ivory) AL (Almond)



Surface Mount Boxes

- Two-piece design; cover and base

Description	Single	25-Pack
1 Port [A]	IC107SB1xx* [Color swatches: WH, IV, BK, GY]	IC107BC1xx* [Color swatches: WH, IV]
2 Ports [B]	IC107SB2xx* [Color swatches: WH, IV, BK, GY]	IC107BC2xx* [Color swatches: WH, IV]
4 Ports [C]	IC107SB4WH [Color swatch: WH]	N/A
6 Ports [D]	IC107SB6WH [Color swatch: WH]	N/A
12 Ports [E]	IC107SBTxx* [Color swatches: WH, IV]	N/A

Elite™	Single
1 Port [F]	IC108SB1xx* [Color swatches: WH, IV]
2 Ports [G]	IC108SB2xx* [Color swatches: WH, IV]
4 Ports [H]	IC108SB4xx* [Color swatches: WH, IV]
6 Ports [I]	IC108SB6xx* [Color swatches: WH, IV]

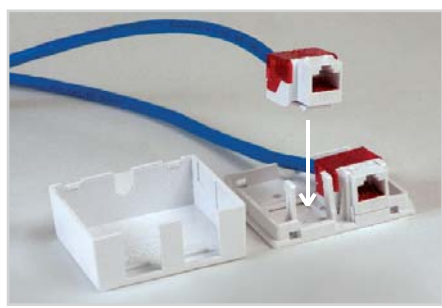

Install connectors tab-side down

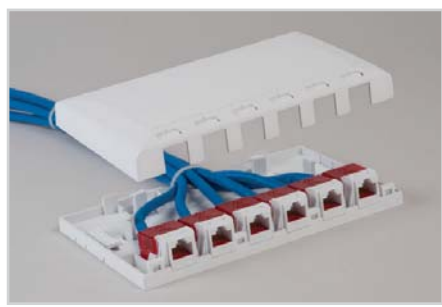

Removable cover

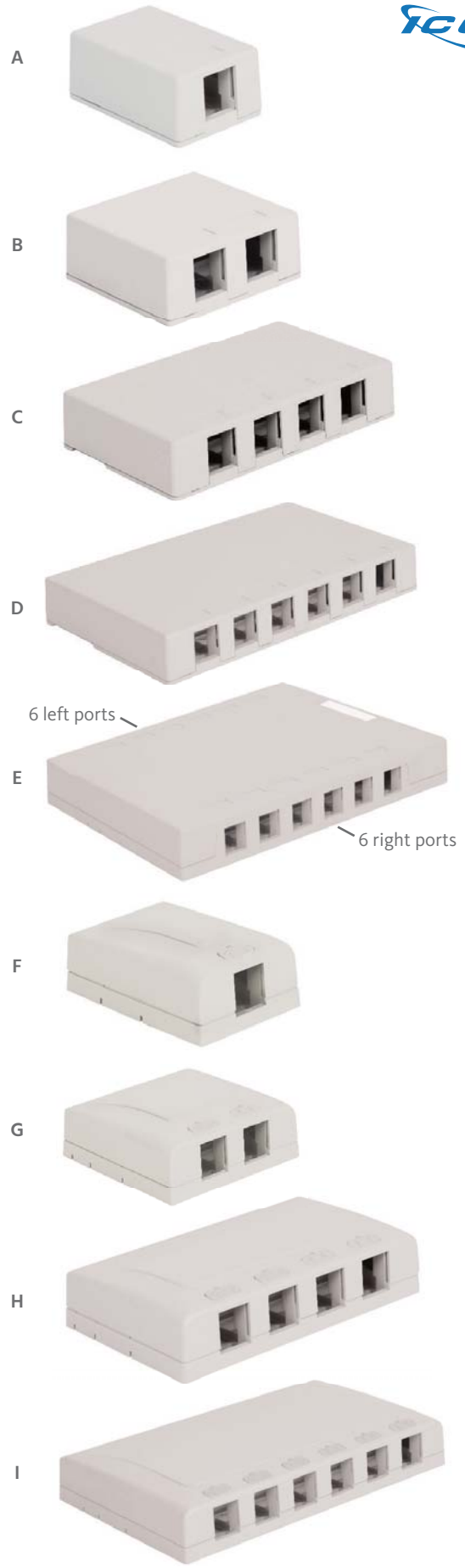

*Colors (xx):

WH (White)	IV (Ivory)	BK (Black)	GY (Gray)

Surface Mount Boxes Kitted with Jacks



- Three-piece design; cover, base, and connector

CAT 5e	Single
1 Port, 1 Connector, IDC termination [A]	IC625S51xx*
2 Ports, 2 Connectors, IDC termination [B]	IC625S52xx*
6P6C	Single
1 Port, 1 Connector, IDC termination	IC625SV1IV
2 Ports, 2 Connectors, IDC termination	IC625SV2IV

A



B

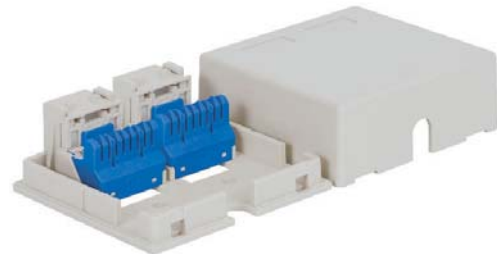

Rear

C



Surface Mount Jack

Description	Single
6P6C, Phillips screw termination [C]	IC625SB6xx*

Mounting Options



Adhesive mount



Screw mount

Wiring System (IC625SB6xx*)				
Wire Color	USOC 4C/6C	USOC 8C	WECO 8C	568 8C
W/BL	4	5	5	5
BL	3	4	4	4
W/OR	2	3	1	3
OR	5	6	2	6
W/GN	1	2	3	1
GN	6	7	6	2
W/BR	N/A	8	7	7
BR		1	8	8

*Colors (xx):

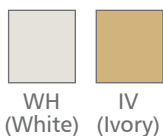

WH (White) IV (Ivory)

Telephone Faceplate with Hanging Standoffs



Phillips Screw Termination Single

6P6C, single gang [A]

IC630DB6xx*

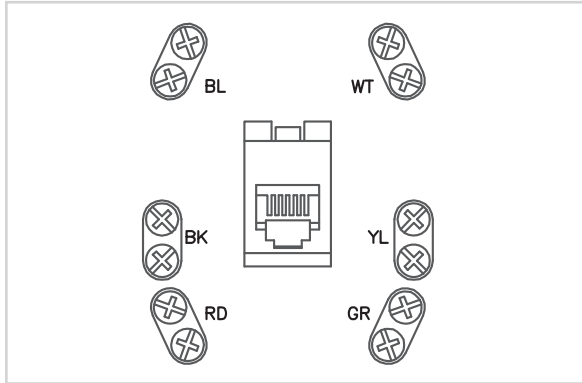

Wiring Diagram

A



Inside



Rear

Stainless Steel Telephone Faceplate with Hanging Standoffs

IDC Termination Single

6P6C, stainless steel, single gang [B]

IC630DA6SS

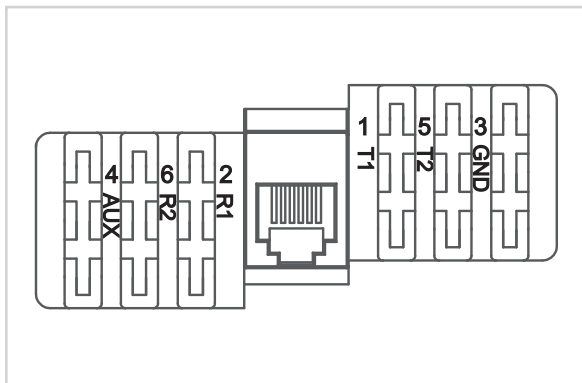

Wiring Diagram

B



Includes 110-punch-down tool



Inside

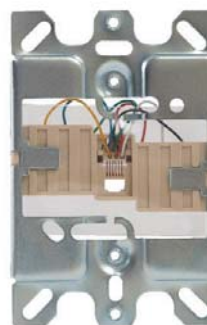

Rear

*Colors (xx):



WH (White) IV (Ivory)

Integrated Faceplates with Screw Termination



- 6P6C port has rear Phillips screw terminals

Description	Single
6P6C, single gang	IC630E60xx*
6P6C and F-Type, single gang [A]	IC630E6GWH
F-Type, single gang [B]	IC630EG0xx*



Rear

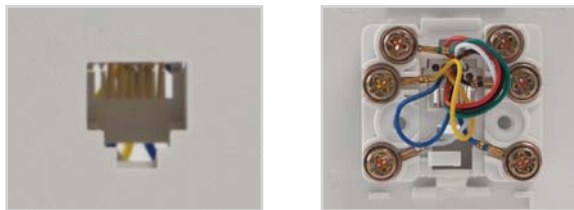

50µ gold-plated contacts

Brass termination lugs



Rear

Category Rated Integrated Faceplates with IDC Termination

- One-piece design

Description	Single
CAT 5e and F-Type, single gang	ICRDS0F5WH
CAT 5e and 6P6C, single gang [C]	ICRDSV05WH
CAT 5e, 6P6C, and F-Type, single gang [D]	ICRDSVF5WH



Rear



Rear IDC terminals with integrated wiring diagrams





Rear

*Colors (xx): WH (White) IV (Ivory)



Mounting Boxes

Description	Single
Single Gang	IC107MRSxx* 
Double Gang [A]	IC107MRDxx* 

A



Junction Boxes

- Two-piece design; box and base

Description	Single
Single Gang [B]	ICACSMBSxx* 
Double Gang	ICACSMBDxx* 

B



Mobile Patch Boxes

Description	Single
Configurable, 6 ports, two-piece design; cover and base [C]	IC107MB6BK
CAT 6, 6 ports, IDC termination	ICMPPMB606
CAT 5e, 6 ports, IDC termination [D]	ICMPPMB506

C



D



Description	Single
Magnet, 2 pcs, can be installed with mobile patch boxes	ICMAGBLOCK

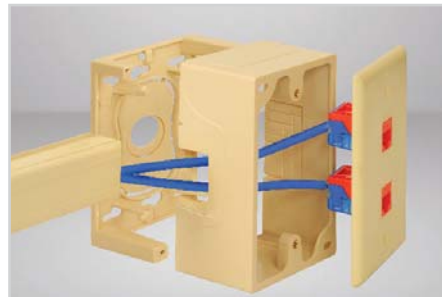

B



C



D

*Colors (xx):

		
WH (White)	IV (Ivory)	BK (Black)



110-Type Patch Panels	20, 22
Blank Patch Panels & Modular Patch Panels	21
Feed-Through Patch Panels	23
110 Wiring Blocks	24, 25
Telco Patch Panels	26
66 Wiring Blocks	27
Mounting Brackets	28

110-Style Patch Panels



24 Port	Single	6-Pack
CAT 6, 1 RMS [A]	ICMPP02460	ICMPP2460V
CAT 6A, 1 RMS [B]	ICMPP0246B	N/A
CAT 5e, 1 RMS	ICMPP0245E	ICMPP245EV
6P6C, USOC, 1 RMS	ICMPP024U6	N/A

48 Port	Single	6-Pack
CAT 6, 2 RMS	ICMPP04860	ICMPP4860V
CAT 6A, 2 RMS [C]	ICMPP0486B	N/A
CAT 5e, 2 RMS	ICMPP0485E	ICMPP485EV
6P6C, USOC, 2 RMS	ICMPP048U6	N/A



Cable Management Bar

- Mounts on the rear of patch panels to support cable
- Does not work with CAT 6A panels

Description	Single
110-Style [D]	ICMPP25CMB

Label Programming Specifications



Center Port Spacing: 0.6"
Tape Width: 3/8" (9mm)

Modular Blank Patch Panels

- Configurable with modular connectors

24 Port	Single
HD, 1 RMS [A]	IC107BP241
EZ Staggered, 1 RMS [B]	IC107BE241
48 Port	Single
HD, 1 RMS [C]	IC107BP481
HD, 2 RMS [D]	IC107BP482

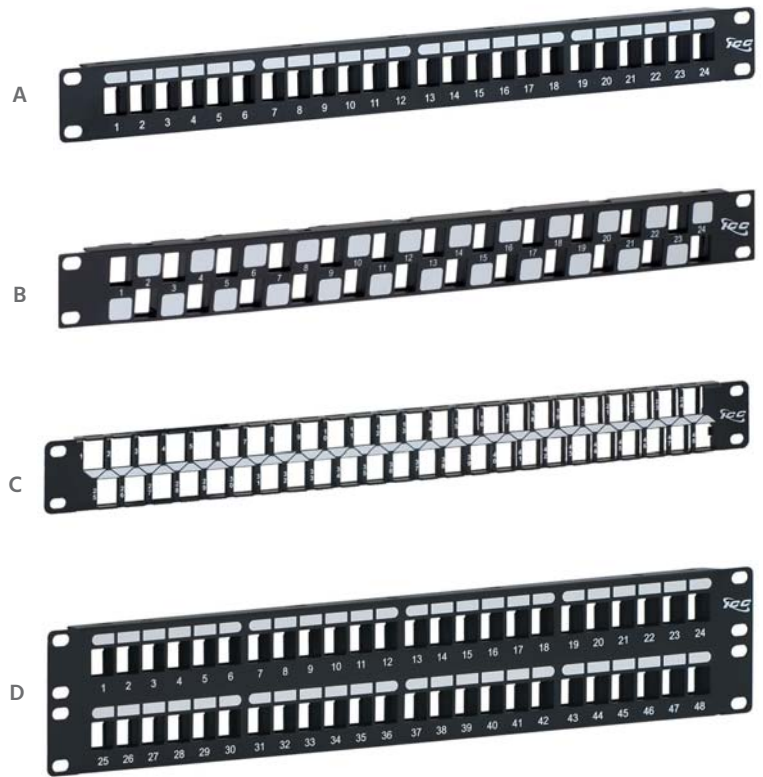

CAT 6A Modular Blank Patch Panels

- Works with CAT 6A connectors

24 Port	Single
Blank, UTP, 1 RMS [E]	IC107PPU6A
Blank, FTP, 1 RMS [F]	IC107PPS6A



CAT 6A Modular Patch Panels

- Comes with 24 keystone connectors

24 Port	Single
CAT 6A, UTP, 1 RMS [G]	ICMPP246AU
CAT 6A, FTP, 1 RMS [H]	ICMPP246AS





110-Style Wall Mount Patch Panels

- Two-piece design; patch panel with 89D mounting bracket

12 Ports	Single	6-Pack
CAT 6 [A]	ICMPP12V60	ICMPP1260V
CAT 5e	ICMPP12V5E	ICMPP125EV
6P6C, USOC	ICMPP012U6	N/A

A



Front Access Zero-U Patch Panels

- Two-piece design; patch panel with cover

12 Ports	Single
CAT 6 [B]	ICMPP12F6E
CAT 5e	ICMPP12F5E

B



Blank Wall Mount Patch Panels

- Two-piece design; patch panel with 89D mounting bracket

12 Ports	Single
HD [C]	IC107BP12V

8 Ports	Single
HD/EZ [D]	IC107BP8VB

C



D



Clear Dust Caps

- Prevents dust and debris from entering ports

Description	10-Pack	100-Pack
Single port	ICACSDCICL	ICACSDCVCL



Feed-Through Coupler Patch Panels



- Comes pre-assembled with category-rated couplers
- Connect patch cords on both sides of panel
- No punch-down termination needed
- Supports Power over Ethernet (PoE++) Type 4; up to 100 watts

24 Port	Single
CAT 6A, 1 RMS	ICMPP24CPA
CAT 6, 1 RMS [A]	ICMPP24CP6
CAT 5e, 1 RMS	ICMPP24CP5
48 Port	Single
CAT 6A, 2 RMS	ICMPP48CPA
CAT 6, 1 RMS [B]	ICMPP48C61
CAT 6, 2 RMS [C]	ICMPP48CP6
CAT 5e, 1 RMS	ICMPP48C51
CAT 5e, 2 RMS	ICMPP48CP5



The top and bottom rows have couplers oriented in opposite directions

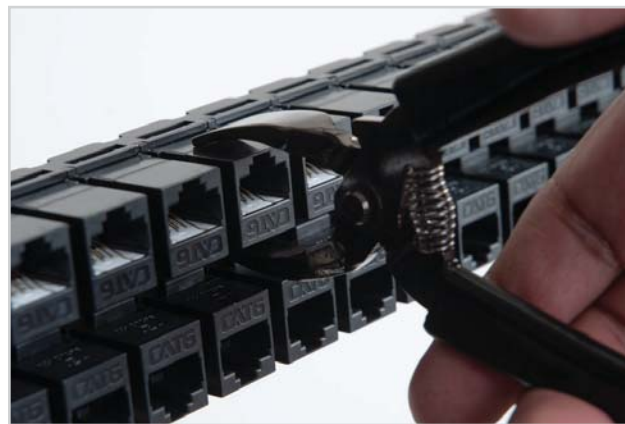

ICC's Connector Removal Tool (ICACSP481) helps remove couplers

110 Wiring Block Kits

- Includes a wiring block with feet
- Includes 110 connecting blocks and labels

CAT 5e	Single
100-Pair	IC110W1004
300-Pair	IC110W3004
100-Pair, Hinged base [A]	IC110H1004

CAT 6	Single
96-Pair [B]	IC110WK966

110 Wiring Blocks

Description	Single
100-Pair with Feet	IC110WF100
300-Pair with Feet [C]	IC110WF300
100-Pair without Feet	IC110NF100
100-Pair, Hinged base	IC110WH100

Cable Managers	Single
With Feet	IC110CMBWF
Without Feet [D]	IC110CMBNF



110 Wiring Block Patch Panels



CAT 5e	Single
100-Pair [A]	IC110RM100
200-Pair	IC110RM200
Cable Manager [B]	IC110RMCMB



110 Wiring Block Patch Panel Kit

- Includes 110 connecting blocks and labels

CAT 6	Single
96-Pair [C]	IC110PRK61

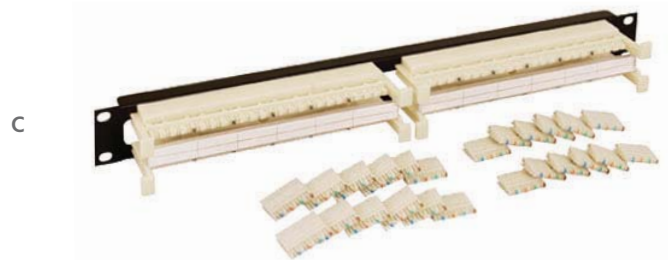

Accessories

110 Connecting Blocks	100-Packs
4-Pair [D]	IC110CB4PC
5-Pair [E]	IC110CB5PC



Other	Value-Packs
Label Holder, 6-Pack [F]	IC110LHLDR
Wire Cap, 50-Pack [G]	IC110TC450

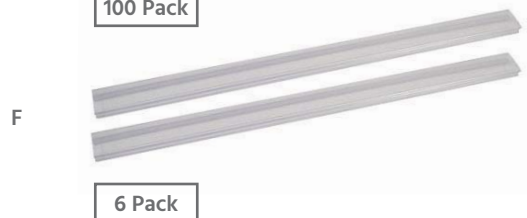

Spools	10-Pack
Built-in wood screw [H]	ICACSWDS20
Without screw [I]	ICACSWDS10



Voice Telco Patch Panels



- RJ-21X 25-Pair (50-pin) Telco connector on the rear

24 Port 1 RMS	Telco Gender	Active Pins	Single
8P4C USOC	2 male	4/5, 3/6	ICMPP24T4C
8P4C USOC	2 female	4/5, 3/6	ICMPP24TF4
8P2C USOC	1 male	4/5	ICMPP24T2C
8P2C USOC [A]	1 female	4/5	ICMPP24TF2
6P4C USOC	2 male	3/4, 2/5	ICMPP024T4
6P4C USOC	2 female	3/4, 2/5	ICMPPTF244
6P2C USOC [B]	1 male	3/4	ICMPP024T2
6P2C USOC	1 female	3/4	ICMPPTF242

48 Port 1 RMS	Telco Gender	Active Pins	Single
8P2C USOC	1 male	4/5	ICMPP48T2C
8P2C USOC	1 female	4/5	ICMPP48TF2
6P2C USOC	1 male	3/4	ICMPP048T2

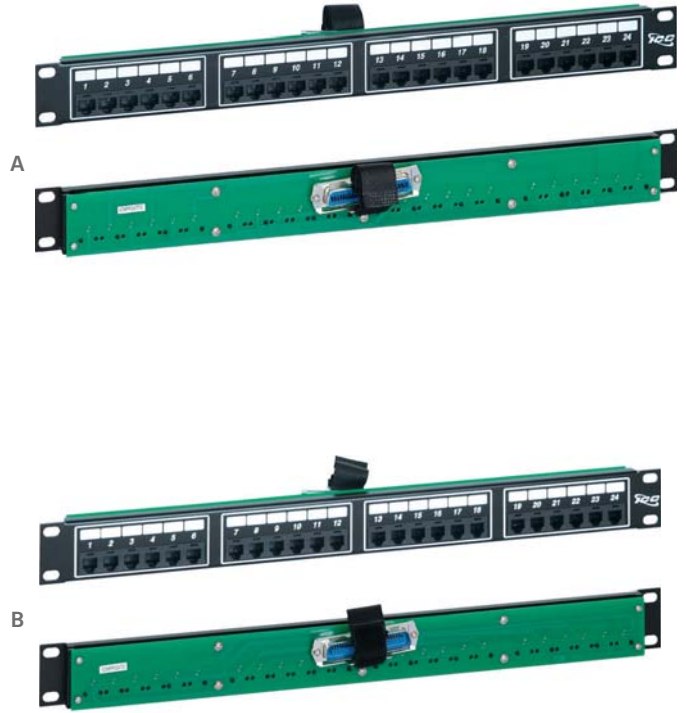

PATCH PANELS AND CROSS-CONNECT

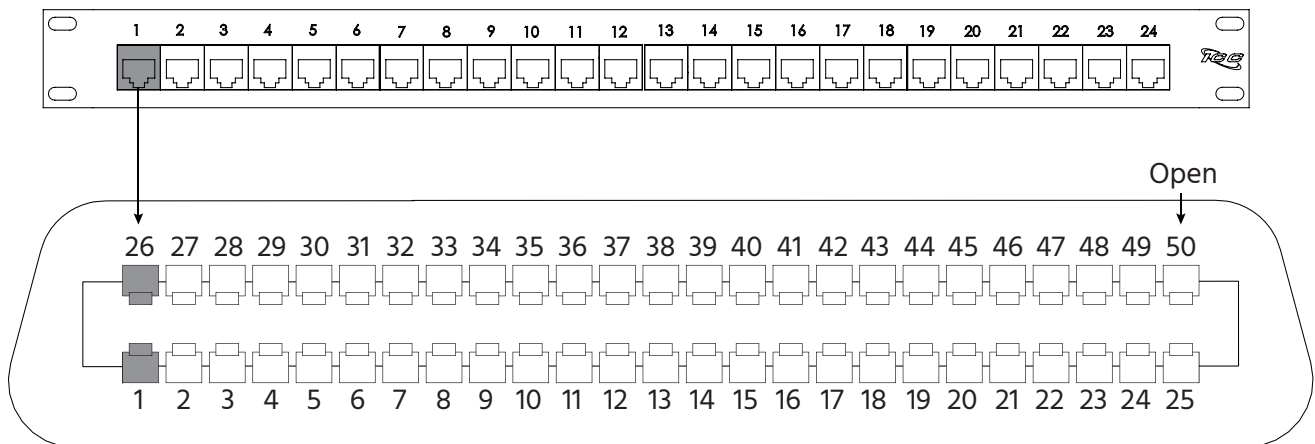
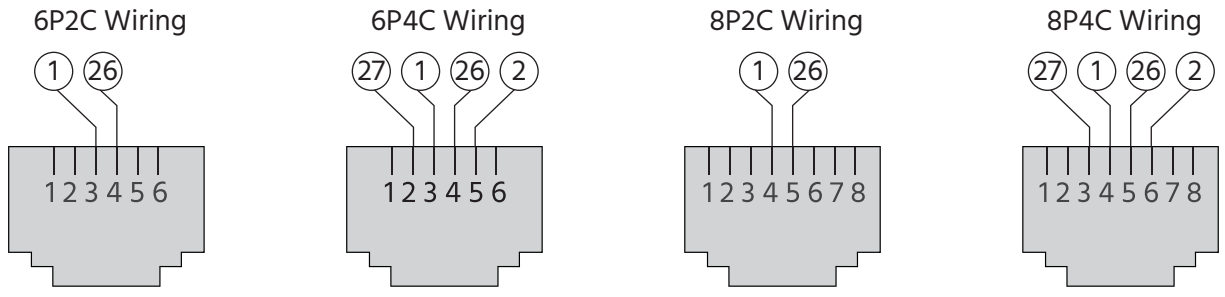



89B Mounting Brackets

- Dimensions: 10" H x 3.30" W x 1.90" D
- For mounting 66 wiring blocks

Description	Single	25-Pack
Bracket [A]	ICMB89B0WH	ICMB89BCWH

A



89D Mounting Bracket

- Dimensions: 10" H x 3.30" W x 1.90" D
- For mounting USOC vertical patch panels

Description	Single
Bracket [B]	ICMB89D0WH

B



89U Mounting Bracket

- Dimensions: 10" H x 3.30" W x 2.35" D
- For mounting vertical patch panels and 66 wiring blocks

Description	Single
Bracket [C]	ICMB89U0WH

C



Accessories

Description	Single
Block Clear Cover [D]	IC066CV050

D



Description	100-Pack
Bridge Clips, 100-Pack [E]	IC066BRCLP

E



100 Pack

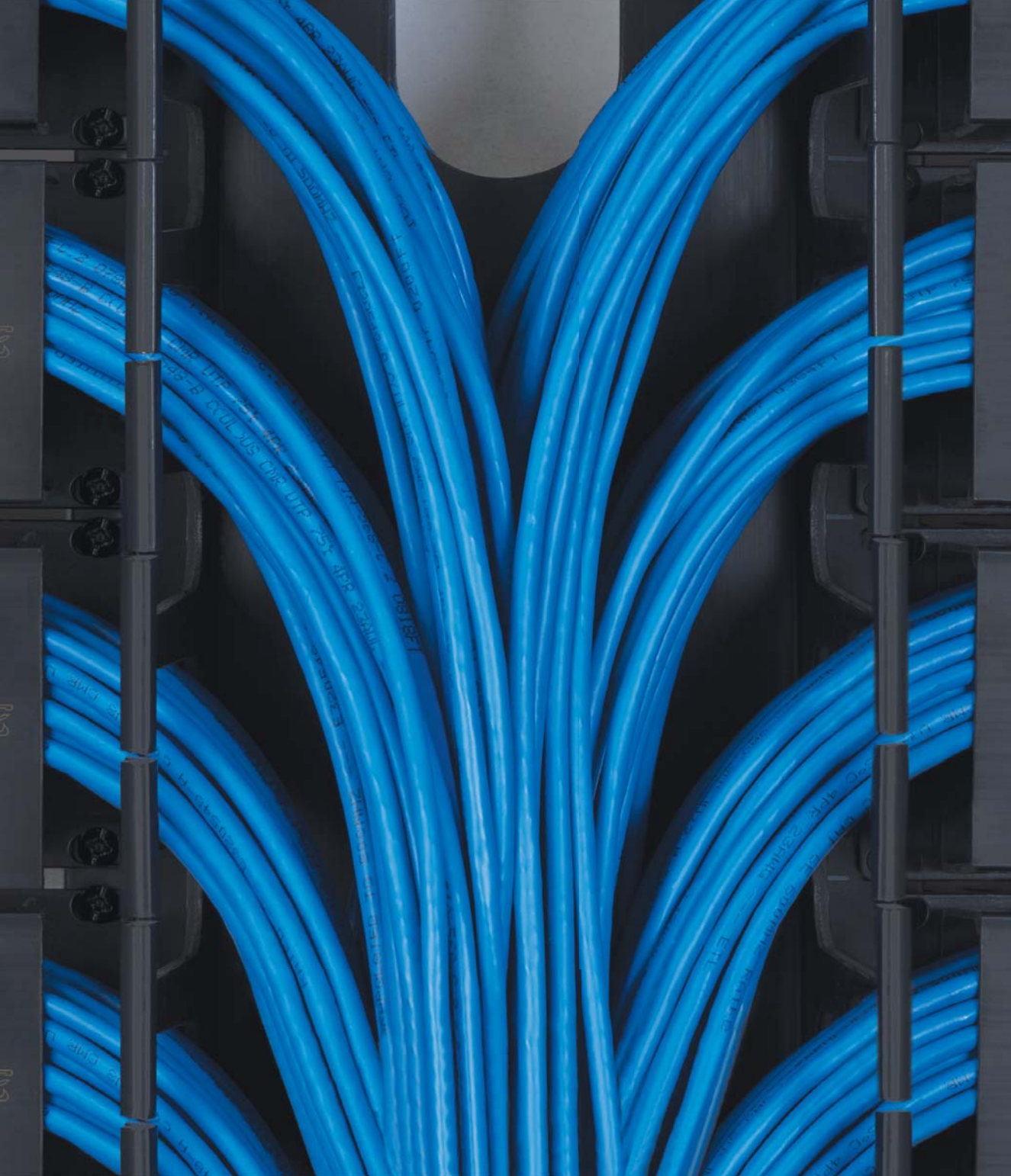

Racks and Cable Management

Wall Mount Brackets	30
Wall Mount Racks	31
Floor Mount Racks	32
Cable Management	33-37
Shelves	38-39
Ladder Rack	40-42



Wall Mount Hinged Brackets

- Up to 40 lb. capacity

Description	Single	2-Pack
1 RMS, 6" D [A]	ICCMSHB1RS	ICCMSHB1RC
2 RMS, 6" D	ICCMSHB2RS	ICCMSHB2RC
4 RMS, 6" D [B]	ICCMSHB4RS	ICCMSHB4RC



Wall Mount EZ-Fold™ Brackets

- Up to 30 lb. capacity
- Patented

Description	Single
2 RMS, 6" D	ICCMSABR62
4 RMS, 6" D	ICCMSABR64
6 RMS, 6" D [C]	ICCMSABR66
8 RMS, 6" D	ICCMSABR68

Description	Single
2 RMS, 15" D [D]	ICCMSABRS2
4 RMS, 15" D	ICCMSABRS4
6 RMS, 15" D	ICCMSABRS6
8 RMS, 15" D	ICCMSABRS8



EZ-Fold Bracket Covers

Description	2-Pack
15" D, top and bottom covers [E]	ICCMSABRSC



Wall Mount Racks

- Up to 125 lb. capacity

Description	Single
8 RMS, 18" D [A]	ICCMSWMR08
15 RMS, 18" D [B]	ICCMSWMR15
30 RMS, 18" D	ICCMSWMR30

A



B

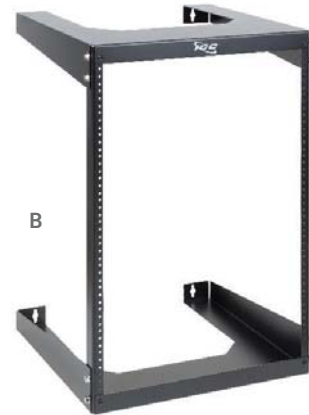

Wall Mount Swing Frame Racks

- Up to 85 lb. capacity
- Frame swings out left or right

Description	Single
12 RMS, 18" D [C]	ICCMSSFR12
25 RMS, 18" D	ICCMSSFR25

C



Wall Mount Utility Rack

- Up to 75 lb. capacity

Description	Single
5 RMS	ICCMSWMUR5



Pilot Point Rack Screws

Description	25-Pack
#12-24 x 5/8"	ICACSS01BK



25 Pack



2-Post Distribution Racks

- Up to 750 lb. capacity

Description	Single
7' H, 45 RMS [A]	ICCMSR1984
6' H, 38 RMS	ICCMSR1972



4-Post Distribution Rack

- Adjustable frame from 27" to 32" depth
- Up to 1500 lb. capacity

Description	Single
7' H, 45 RMS [B]	ICCMSR4P84

Vertical Finger Duct

- Includes plastic cover
- Vertical finger ducts with Z-Brackets are recommended for horizontal finger duct brackets with 3-inch depth

Single-Sided	Single
2-Pack, Side or Center Mount, Flat Bracket 78" H x 6" W x 5" D [C]	ICCMSMA73
Side Mount, Flat Bracket 78" H x 4" W x 5" D [D]	ICCMSMA84
Side Mount, Z-Bend Bracket 78" H x 4" W x 5" D	ICCMSMA81

Double Sided	Single
Center Mount, Z-Bend Bracket 78" H x 4" W x 10" D	ICCMSMA82
Side Mount, Z-Bend Bracket 78" H x 4" W x 10" D [E]	ICCMSMA83

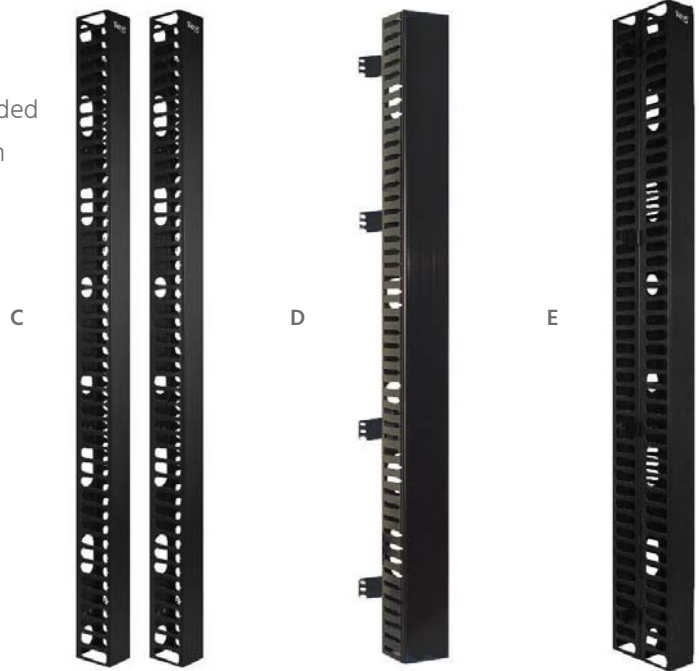

Anchor Kit

- Secures rack to concrete

Description	4-Pack
3/8" anchor with mounting hardware	ICCMSRFLKT

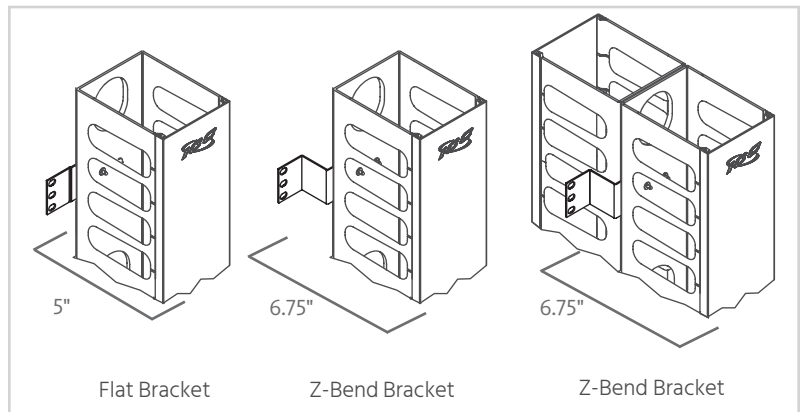

Vertical Metal Channels

- Includes plastic covers

Description	1 Set	2 Sets
Side or Center Mount, Flat Bracket 40" H x 6" W x 6" D	ICCMSC42BK	ICCMSC40BK



Adjustable Bracket and Front Latch

Vertical Plastic Finger Ducts

- Includes plastic covers

Description	2 Sets
Side or Center Mount, Flat Bracket 35" H x 4" W x 5" D	ICCMSC30BK



Adjustable Bracket



2 Sets



Open

2 Sets



Open

Single-Sided Finger Ducts



Description	3" Depth	5" Depth
1 RMS	ICCMSCMA41	ICCMSCMA15 [A]
1 RMS, 6-Pack	ICCMSCMAC1	N/A
2 RMS	ICCMSCMA42	ICCMSCMA25 [B]
2 RMS, 6-Pack	ICCMSCMAC2	N/A



Metal Blank Panels

Description	Single	12-Pack
1 RMS [C]	ICCMSCMPB1	ICCMSCMPC1
2 RMS	ICCMSCMPB2	ICCMSCMPC2
3 RMS	ICCMSCMPB3	N/A
4 RMS [D]	ICCMSCMPB4	N/A



Cable Management Bracket Panels

Description	6-Pack
Front, 3" D [E]	ICCMSFCMC3
Rear, 5" D [F]	ICCMSRCMC5



Plastic Interbay Ring Panels



Description	Single	6-Pack
1 RMS [A]	ICCMSCMA51	ICCMSCMAV1
2 RMS [B]	ICCMSCMA52	ICCMSCMAV2



Metal Vertical Ring Panels

Description	Single	6-Pack
1 RMS [C]	ICCMSCMPK1	ICCMSCMP61
2 RMS [D]	ICCMSCMPK2	ICCMSCMP62



Metal Vertical and Horizontal Ring Panels

Description	Single
1 RMS [E]	ICCMSCMP31
2 RMS [F]	ICCMSCMP32



4"

2"

1-5/16"

3/4"

A



B



C



D



Description	Wall Mount [A]	Ceiling Mount [B]	Batwing [C]	Beam Clamp [D]
4" D	ICCMSJHK55	ICCMSJH955	ICCMSJHW55	ICCMSJHB55
2" D	ICCMSJHK44	ICCMSJH944	ICCMSJHW44	ICCMSJHB44
1-5/16" D	ICCMSJHK33	ICCMSJH933	ICCMSJHW33	ICCMSJHB33
3/4" D	ICCMSJHK22	ICCMSJH922	ICCMSJHW22	ICCMSJHB22

Universal Vertical/Horizontal Plastic Ring



Description	Single	10-Pack
3" H x 3" W [A]	ICCMSCMPR7	ICCMSCMPV7



Vertical and Horizontal Plastic Rings

Description	Single	10-Pack
1.25" W [B]	ICCMSCMPR5	ICCMSCMPV5
1.25" H [C]	ICCMSCMPR6	ICCMSCMPV6



Vertical Metal Rings

Description	10-Pack
1.70" W [D]	ICCMSCMPT1
3" W	ICCMSCMPT2



10 Pack

Metal "L" Bracket

Description	25-Pack
0.95" H x 6" W [E]	ICCMSCMPLC



25 Pack

Wall Mount D-Rings

Description	Plastic 25-Pack	Metal 25-Pack	Plastic 100-Pack	Metal 100-Pack
2"	ICCMSDRPC2	ICCMSDRMC2	ICCMSDRP02 [F]	ICCMSDRM02 [G]
3"	ICCMSDRPC3	ICCMSDRMC3	ICCMSDRP03	ICCMSDRM03
5"	ICCMSDRPC5	ICCMSDRMC5	ICCMSDRP05	ICCMSDRM05



100 Pack

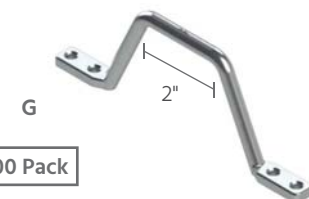

100 Pack

Cable Radius Manager

Description	20-Pack
2.44" H x 3.6" W [H]	ICCMSRMU1C



20 Pack



Solid Bottom Rack Shelves

- Up to 250 lb. capacity

Description	Single	2-Pack
10" D, 2 RMS, single-sided	ICCMSRSF10	ICCMSRSFC1
15" D, 3 RMS, single-sided [A]	ICCMSRSF15	ICCMSRSFC2
20" D, 2 RMS, double-sided [B]	ICCMSRDS20	ICCMSRDSC3
20" D, 3 RMS, double-sided [C]	ICCMSHDS20	N/A

A



B



C



Solid Bottom Keyboard Shelf with Sliding Mouse Tray

- Up to 10 lb. capacity

Description	Single
10" D, 3 RMS	ICCMSRKSMT



Vented Bottom Rack Shelves



- Up to 100 lb. capacity

Description	Single	2-Pack
10" D, 2 RMS, single-sided	ICCMSRSV10	ICCMSRSVC1
15" D, 3 RMS, single-sided [A]	ICCMSRSV15	ICCMSRSVC2
20" D, 2 RMS, double-sided [B]	ICCMSRDV20	ICCMSRDVC4
30" D, 3 RMS, double-sided	ICCMSRDV30	N/A

A



B



Vented Bottom Wall Shelf

- Up to 125 lb. capacity

Description	2-Pack
17" D	ICCMSWMSV2

2 Pack



The Difference Between Vented and Solid Shelves



Vented shelves provide airflow to ventilate mounted equipment



Solid shelves support heavier equipment

Ladder Rack Kit (Straight)

- Runway, relay bracket, wall angle, and J-Bolts

Description	Single
5'	ICCMCLR05

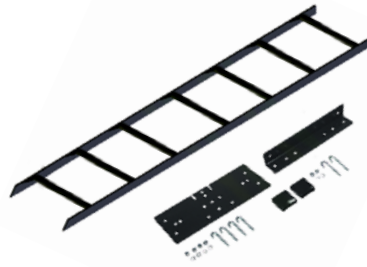

Ladder Rack Runway (Straight)

- 16 GA steel with a durable powder-coated finish
- 2-Pack of 5' with butt splice make 10'
- 2-Pack of 7' make 14'

Description	Single	2-Pack
5' [A]	ICCMCLST05	ICCMCLSTV5
5' with Butt Splice Kit [B]	N/A	ICCMCLSTW5
7' [C]	N/A	ICCMCLSTV7

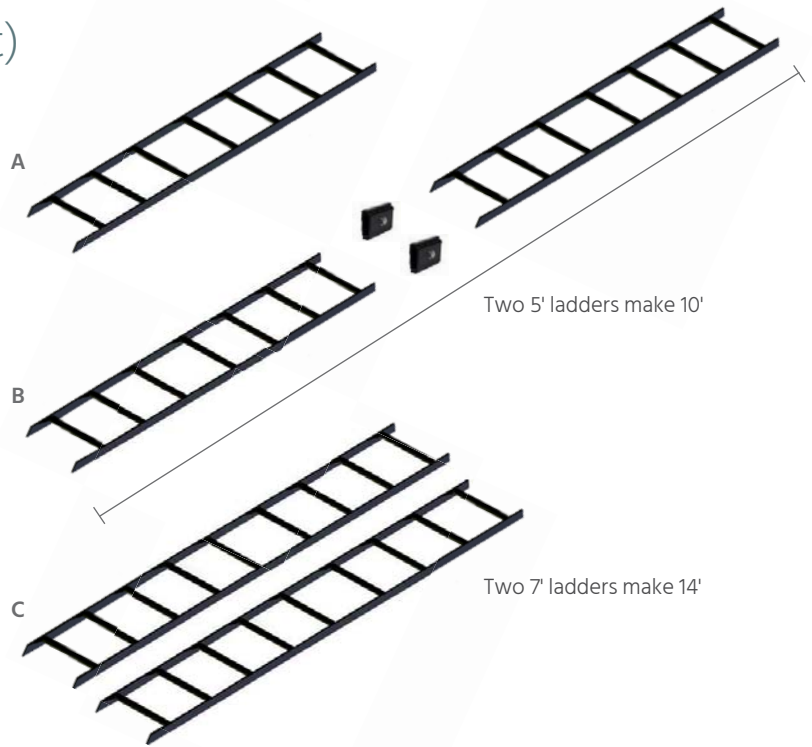

90° Flat Turn

- Gradual sweeping bend

Description	Single
Horizontal Flat Turn [D]	ICCMCLFT90



90° Corner Turns

- Routes cable vertically

Description	Single
Vertical Inside Turn [E]	ICCMCLIR90
Vertical Outside Turn [F]	ICCMCLOR90



Cable Radius Drop

- Maintains cable's bend radius at drop points
- Attach to the middle rungs or side rail

Description	2-Pack
-------------	--------

90-degree curve ICCMSLRDB

2 Pack



Wall Support Triangle

- Holds ladder rack to wall

Description	6-Pack
-------------	--------

Side rail support ICCMSLTWS6

6 Pack



Wall Support Bracket

- Holds ladder rack ends to wall

Description	2-Pack
-------------	--------

End support ICCMSLAWS2

2 Pack



Butt Splices

- Joins ladder rack ends together

Description	10-Pack
-------------	---------

Joint support ICCMSLRBSK

10 Pack



Cable Retaining Post

- Prevents cable from falling off the side

Description	10-Pack
-------------	---------

Side rail support ICCMSLRCP

10 Pack

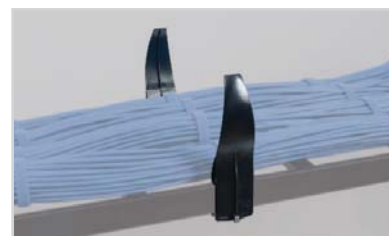

Floor Mount Feet

Description	2-Pack
-------------	--------

End support ICCMSLMFF2

2 Pack



Relay Rack Brackets

Description	Single
2-Post rack bracket [A]	ICCM SLRRBK
4-Post rack bracket [B]	ICCM SL4PBK

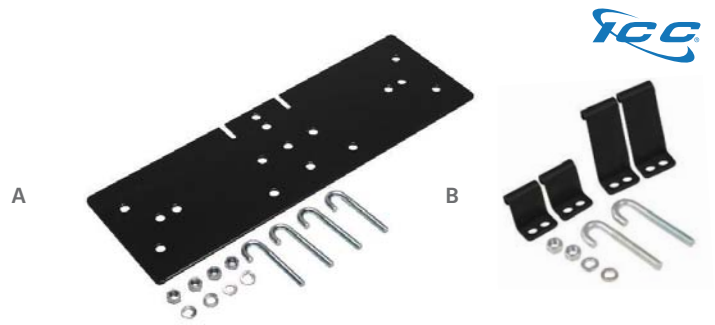

Wall Bracket

Description	2-Pack
Side rail support	ICCM SLVWBK

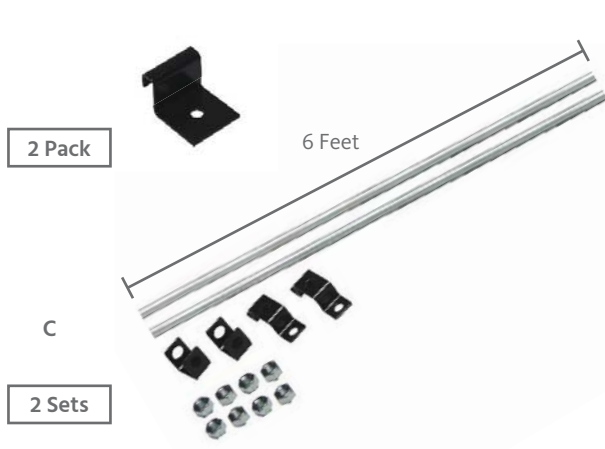

6' Threaded Ceiling Rod

Description	2-Sets
Overhead support [C]	ICCM SLCMRK

Swivel Butt Splice

- Allows ends to adjust to 180°

Description	2-Pack
Joint support	ICCM SLESSK



Tee-Junction Splice

Description	2-Sets	6-Pack
Tee intersection joint support	ICCM SLTJSK	ICCM SLTJS6



J-Bolt

Description	2-Sets
Secures ladder to bracket	ICCM SLJB01



Protective End Caps

Description	2-Pack
Rubber cover	ICCM SLPECK



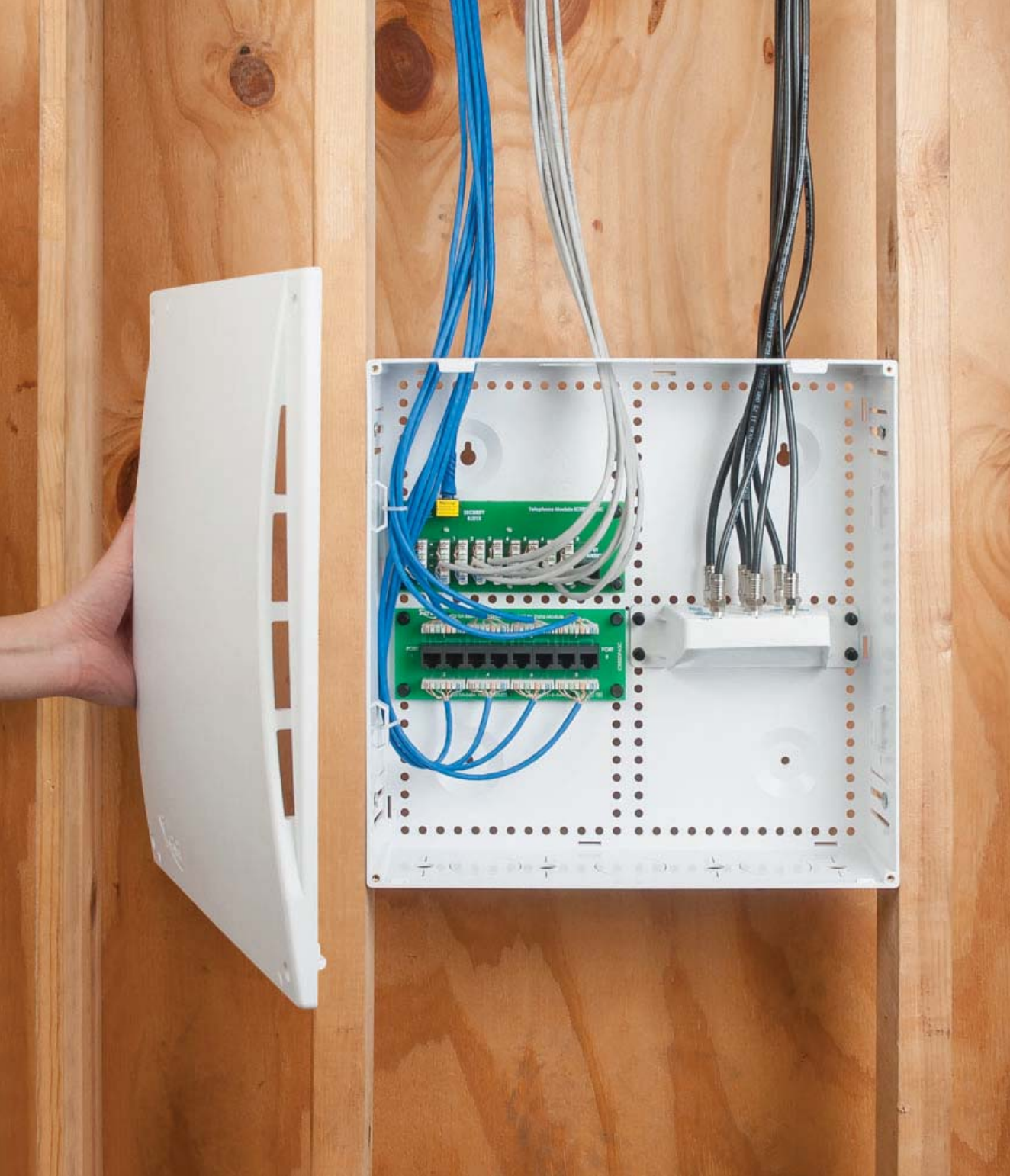

Residential Enclosures

Plastic Enclosures	44-45
Metal Enclosures	45
Connectivity Modules	46-47
Accessories	48

Modular Plastic Residential Enclosures



- Modules are packaged separately so that they can be installed later
- ABS plastic for improved Wi-Fi signal range
- 0.1-inch gauge base to prevent cracking
- Complies with UL 1863, TIA-568-C, TIA-570-B, and TIA-607 standards
- UL® 94V-0 safety rated



Size	Model	Description	Single
14" [A]	K	8-Port CAT 6 data, 8-Port voice with RJ-31X jack, 1x6 video 2 GHz	ICRESDP14K
14"	W	8-Port CAT 6 data, 8-Port voice with RJ-31X jack	ICRESDP14W
14"	E	Enclosure with cover	ICRESDP14E
9" [B]	K	8-Port CAT 6 data, 8-Port voice with RJ-31X jack, 1x6 video 2 GHz	ICRESDC9PK
9"	W	8-Port CAT 6 data, 8-Port voice with RJ-31X jack	ICRESDC9PW
28" [C]	K	8-Port CAT 6 data, 8-Port voice with RJ-31X jack, 1x6 video 2 GHz	ICRESDP28K



Mud guard to protect from the rough-in phase



Universal hole pattern works with most electronic modules

Pre-configured Plastic Residential Enclosures



- Modules are integrated for quick installation

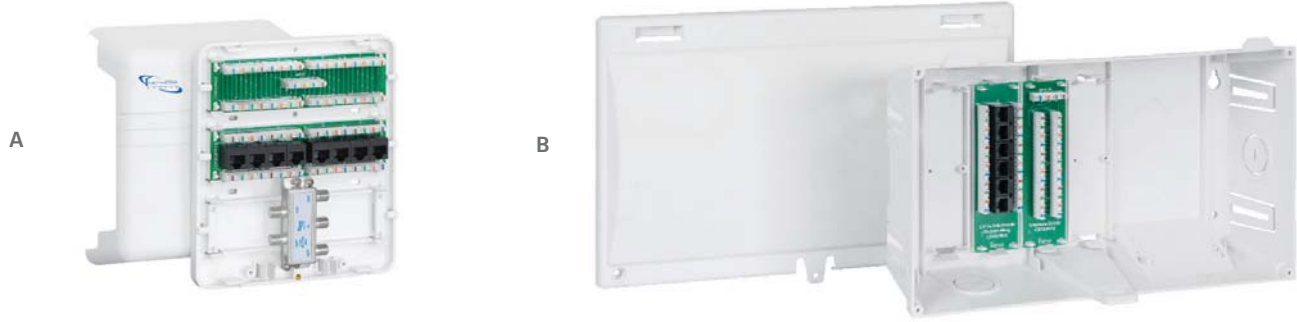

Size	Model	Description	Single	6-Pack
Mini [A]	K	8-Port CAT 5e data, 8-Port voice, 1x4 video 2 GHz	ICRDSMMBK1*	N/A
Mini	W	6-Port CAT 5e data, 6-Port voice	ICRDSMMBW1*	N/A
8" [B]	W	6-Port CAT 5e data, 6-Port voice	ICRDSMMAW8*	ICRDSMMBW8

*Modules are pre-configured into the enclosure

Modular Metal Residential Enclosures

Size	Model	Description	Single
14" [C]	K	8-Port CAT 6 data, 8-Port voice with RJ-31X jack, 1x6 video 2 GHz	ICRESDC14K
14"	W	8-Port CAT 6 data, 8-Port voice with RJ-31X jack	ICRESDC14W
21"	K	8-Port CAT 6 data, 8-Port voice with RJ-31X jack, 1x6 video 2 GHz	ICRESDC21K
21"	E	Enclosure with door	ICRESDC21E
28"	K	8-Port CAT 6 data, 8-Port voice with RJ-31X jack, 1x6 video 2 GHz	ICRESDC28K
28"	E	Enclosure with door	ICRESDC28E



CAT 6 Modules

- 8 Ports, 110-type IDC



Description	Single	10-Pack
PCB Board [A]	ICRESDPB3C	ICRESDPB3D
PCB Board, steel cover [B]	ICRESDPB1C	N/A

A



B

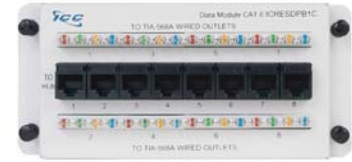

CAT 5e Modules

- 8 Ports, 110-type IDC

Description	Single	10-Pack
PCB Board [C]	ICRESDBA3C	ICRESDBA3D
PCB Board, steel cover [D]	ICRESDBA1C	N/A

C



D



Voice Modules

- 8 Ports bridged IDC; built-in RJ-31X and expansion jacks

Description	Single	10-Pack
PCB Board [E]	ICRESVPA3C	ICRESVPA3D
PCB Board, steel cover [F]	ICRESVPA1C	N/A

E



F



Expansion Modules

- 8 Ports bridged IDC; built-in expansion jack
- Includes a 9" 8P8C flat patch cord

Description	Single
PCB Board [G]	ICRESVPB3C
PCB Board, steel cover [H]	ICRESVPB1C

G



H



Video Splitters

- Video supports 2 GHz, 5~2300 MHz bandwidth
- Voice supports up to 4 phone lines to 8 locations

Description	Video	Video + 8-Port Voice
1 x 4	ICRESAV42L [A]	ICRES8V42S
1 x 6	ICRESAV62L [B]	ICRES8V62S [D]
1 x 6, 10-Pack	ICRESAV62V	N/A
1 x 8	ICRESAV82L [C]	ICRES8V82S

A



B



C



D



Modules With Hook-and-Loop Adhesive Mounting Strips

- Built with rear hook-and-loop adhesive strips to stick on flat surfaces

Description	Single	10-Pack
8-Port CAT 6 data [E]	ICRESDPB2U	ICRESDPB2W
8-Port CAT 5e data [F]	ICRESDPA2U	ICRESDPA2W
8-Port voice with an RJ-31X jack [G]	ICRESVPA2U	ICRESVPA2W

E



F



G

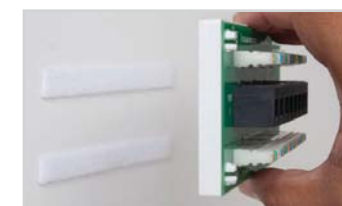

Patch Panels

- Configurable with voice, data, and video connectors

Description	Single
6 HD Ports [H]	ICRESBMP06
4 EZ® Ports	ICRESBMP04

H



Metal Replacement Doors and Trim



- Trim conceals uneven drywall cuts

Description	Single	10-Pack
14" Door [A]	ICRESDR14H	N/A
14" Trim [B]	N/A	ICRESDR14T
21" Door	ICRESDR21H	N/A
28" Door	ICRESDR28H	N/A

A



B



Electronics Bracket

Description	Single
Metal bracket with hook and loop straps	ICRESDCBUM



Cable Management Cover

Description	Single
Metal cover	ICRESCMC06



Protective Grommets

Description	10-Pack
Plastic [C]	ICRESDCAC3
Rubber	ICRDSDCAC2

C



10 Pack

Door Lock and Keys

- Install on 14", 21", and 28" metal doors

Description	Single
Lock and two keys	ICRDSDC2LK



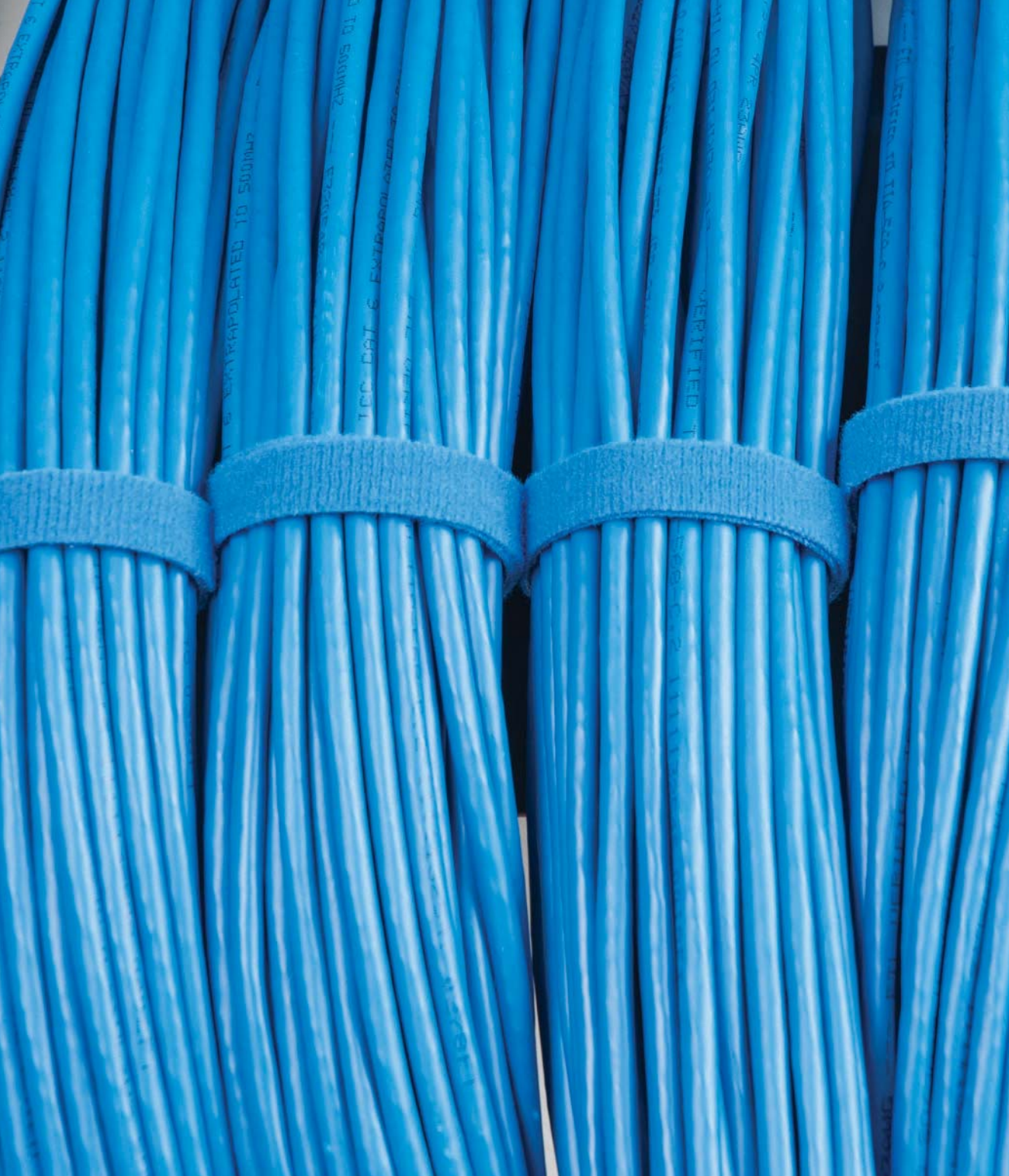

Premise Cables

CMR Bulk Cable

50

CMP Bulk Cable

51

CAT 6A CMR 10G 650 MHz Cable



- TAA compliant

Description	Weight	Length	Size	SKU
UTP Riser	50 lbs.	1000'	23 AWG	ICCABR6Axx*

Description	Weight	Length	Size	SKU
FTP Riser	46 lbs.	1000'	23 AWG	ICCABR6FBL

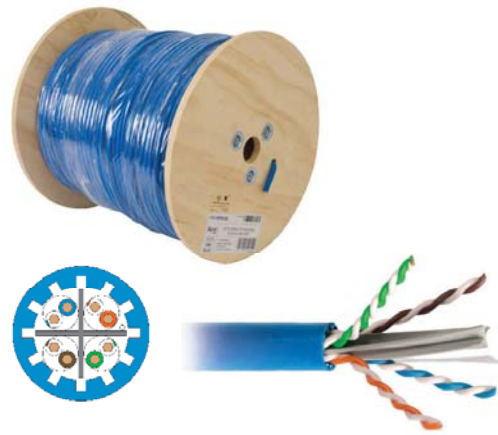

CAT 6e CMR UTP 600 MHz Cable

Description	Weight	Length	Size	SKU
UTP Riser	29 lbs.	1000'	23 AWG	ICCABR6Exx*



CAT 6 CMR UTP 500 MHz Cable

Description	Weight	Length	Size	SKU
UTP Riser	27 lbs.	1000'	23 AWG	ICCABR6Vxx*



CAT 5e CMR UTP 350 MHz Cable

Description	Weight	Length	Size	SKU
UTP Riser	22 lbs.	1000'	24 AWG	ICCABR5Exx*



NOTE: Cable must be stored above 32°F (0°C) for 48 hours before installation. The installation environment must be at or above 32 F (0°C).

Colors (xx)*:

BL (Blue)	WH (White)	BK (Black)	YL (Yellow)	GN (Green)	GY (Gray)

CAT 6A CMP 10G 650 MHz Cable

• TAA compliant

Description	Weight	Length	Size	SKU	
UTP Plenum	54 lbs.	1000'	23 AWG	ICCABP6Axx*	(P)
UTP Plenum	54 lbs.	1000'	23 AWG	ICCABT6Axx*	(T)
Description	Weight	Length	Size	SKU	
FTP Plenum	51 lbs.	1000'	23 AWG	ICCABP6FBL	(P)
FTP Plenum	51 lbs.	1000'	23 AWG	ICCABT6FBL	(T)



CAT 6e CMP UTP 600 MHz Cable

Description	Weight	Length	Size	SKU	
UTP Plenum	31 lbs.	1000'	23 AWG	ICCABP6Exx*	(P)
UTP Plenum	27 lbs.	1000'	23 AWG	ICCABT6Exx*	(T)



CAT 6 CMP UTP 500 MHz Cable

Description	Weight	Length	Size	SKU	
UTP Plenum	27 lbs.	1000'	23 AWG	ICCABP6Vxx*	(P)
UTP Plenum	27 lbs.	1000'	23 AWG	ICCABT6Vxx*	(T)

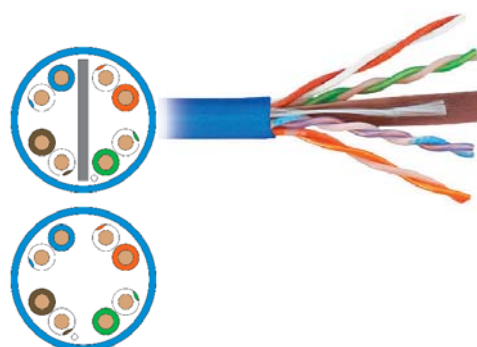

CAT 5e CMP UTP 350 MHz Cable

Description	Weight	Length	Size	SKU	
UTP Plenum	22 lbs.	1000'	24 AWG	ICCABP5Exx*	(P)
UTP Plenum	22 lbs.	1000'	24 AWG	ICCABT5Exx*	(T)



Colors (xx)*:

BL (Blue)	WH (White)	YL (Yellow)	GN (Green)	GY (Gray)

NOTE: Cable must be stored above 32°F (0°C) for 48 hours before installation. The installation environment must be at or above 32 F (0°C).

(P) = United States
(T) = Taiwan, TAA compliant

REELEX II®

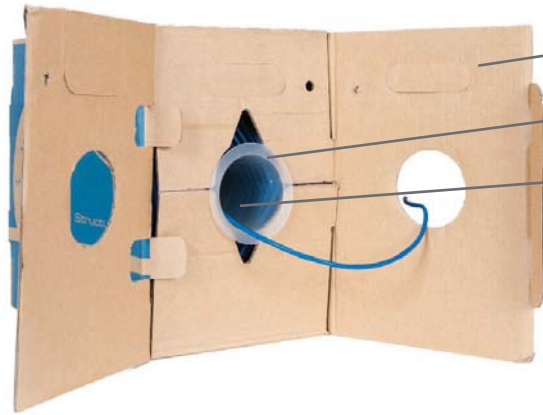

- Double-layer panels for durability
- Wide hole for fast dispensing
- Tube extends 12.5" into carton for balance

- Stackable up to three cartons
- No locking ring that can cause snags
- 100% recyclable



REELEX II® Carton

Reinforced handles and panels

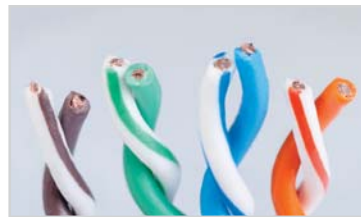

PoE++ Compliant

Made with pure solid copper conductors



REELEX II® Coiling

Figure-eight winding ensures twist cancels out



Footage Markings

Sequential footage to track usage easily



3.5" Payout

Pulls up to 30% faster with no overruns



UL® Mark

Certified holographic seal for authenticity

NOTE:

Do not push cables back into the Reellex carton.
Do not toss the carton with cable.

Cable must be stored above 32°F (0°C) for 48 hours before installation. The installation environment must be at or above 32 F (0°C).



Cords and Cable Assemblies

Patch Cords	54-56
Telco Cables	57
Cable Ties	58
Modular Plugs	58

CAT 6A Patch Cords

- Unshielded Foiled Twisted Pair (U/FTP) for shielded applications
- Wired to T568B standards

Description	Single	10-Pack
1-Foot	N/A	ICPCSX01xx*
3-Foot	ICPCSG03xx*	ICPCSX03xx*
5-Foot	ICPCSG05xx*	ICPCSX05xx*
7-Foot	ICPCSG07xx*	ICPCSX07xx*
10-Foot	ICPCSG10xx*	ICPCSX10xx*
15-Foot	ICPCSG15xx*	N/A
25-Foot	ICPCSG25xx*	N/A

*Colors (xx):

WH BL BK YL OR RD GN GY



CAT 6 Patch Cords With Clear Boots

- Wired to T568B standards

Description	Single	10-Pack	25-Pack Blue
1-Foot	ICPCST01xx*	ICPCSW01xx*	ICPCSF01BL
3-Foot	ICPCST03xx*	ICPCSW03xx*	ICPCSF03BL
5-Foot	ICPCST05xx*	ICPCSW05xx*	ICPCSF05BL
7-Foot	ICPCST07xx*	ICPCSW07xx*	ICPCSF07BL
10-Foot	ICPCST10xx*	ICPCSW10xx*	ICPCSF10BL
14-Foot	ICPCST14xx*	N/A	N/A
25-Foot	ICPCST25xx*	N/A	N/A

*Colors (xx):

WH BL BK YL OR RD GN GY



CAT 6 Slim Patch Cords With Clear Boots



- The diameter of the cable is 36% thinner than standard CAT 6 cables

Description	Single	10-Pack	25-Pack Blue
1-Foot	ICPCSH01xx*	ICPCSY01xx*	ICPCSN01BL
3-Foot	ICPCSH03xx*	ICPCSY03xx*	ICPCSN03BL
5-Foot	ICPCSH05xx*	ICPCSY05xx*	ICPCSN05BL
7-Foot	ICPCSH07xx*	ICPCSY07xx*	ICPCSN07BL
10-Foot	ICPCSH10xx*	ICPCSY10xx*	ICPCSN10BL
15-Foot	ICPCSH15xx*	N/A	N/A
20-Foot	ICPCSH20xx*	N/A	N/A

*Colors (xx):

WH BL BK YL GN GY



CAT 5e Patch Cords With Clear Boots

- Wired to T568B standards

Description	Single	10-Pack	25-Pack Blue
1-Foot	ICPCSP01xx*	ICPCSV01xx*	ICPCSM01BL
3-Foot	ICPCSP03xx*	ICPCSV03xx*	ICPCSM03BL
5-Foot	ICPCSP05xx*	ICPCSV05xx*	ICPCSM05BL
7-Foot	ICPCSP07xx*	ICPCSV07xx*	ICPCSM07BL
10-Foot	ICPCSP10xx*	ICPCSV10xx*	ICPCSM10BL
14-Foot	ICPCSP14xx*	N/A	N/A
25-Foot	ICPCSP25xx*	N/A	N/A

*Colors (xx):

WH BL BK YL GN

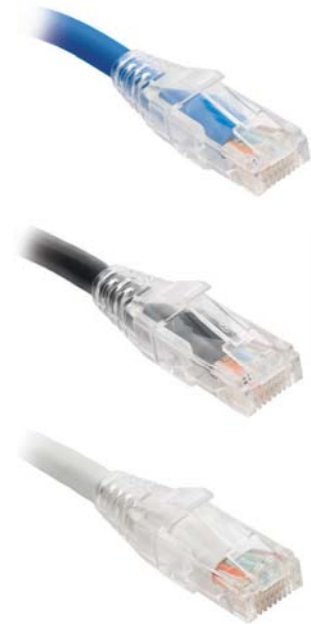

CAT 6A Patch Cords

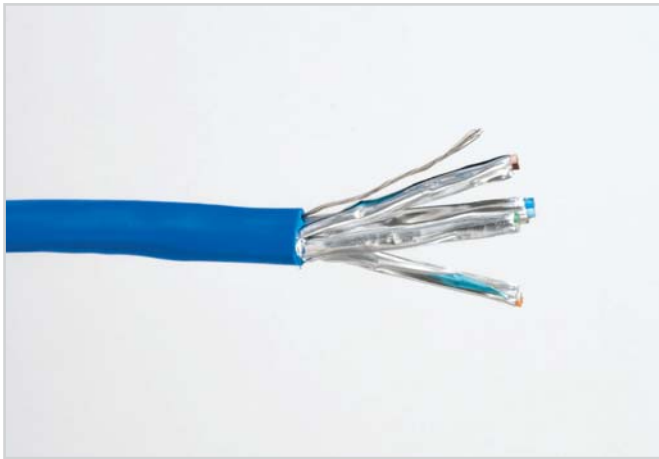

Foiled twisted pairs for protection from Alien Crosstalk

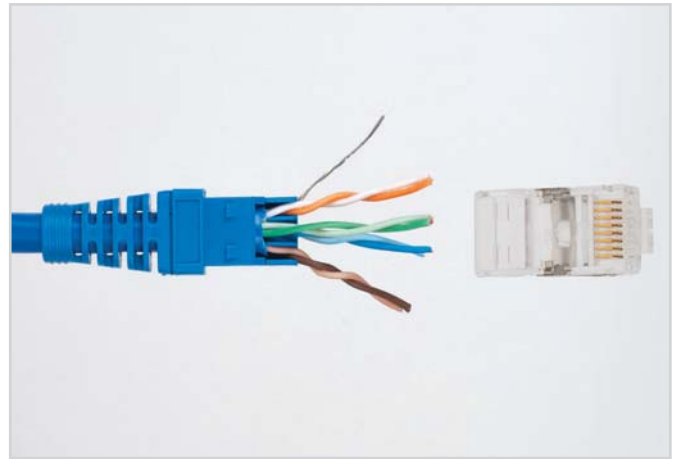

Metal shielded plug and split pairs for enhanced crosstalk cancelation

CORDS AND CABLE ASSEMBLIES

CAT 6 Patch Cords vs. CAT 6 Slim Patch Cords



Patch Cord vs. Slim Patch Cord

Outside Diameter: Standard 0.236" vs. Slim 0.149"



Flexible

Slim patch cords use 38% less space

Telco Cables

- Made with 25-Pair RJ-21X IDC connectors

Description	Single
Male to Male	ICPCSTMMzz**
Female to Female	ICPCSTFFzz**
Female to Male	ICPCSTFMzz**
Male to Blunt [A]	ICPCSTMBzz**
Female to Blunt [B]	ICPCSTFBzz**

**Lengths (zz)= 05', 10', 15', and 25'



A (Male)



B (Female)



Solderless joints,
terminated IDC





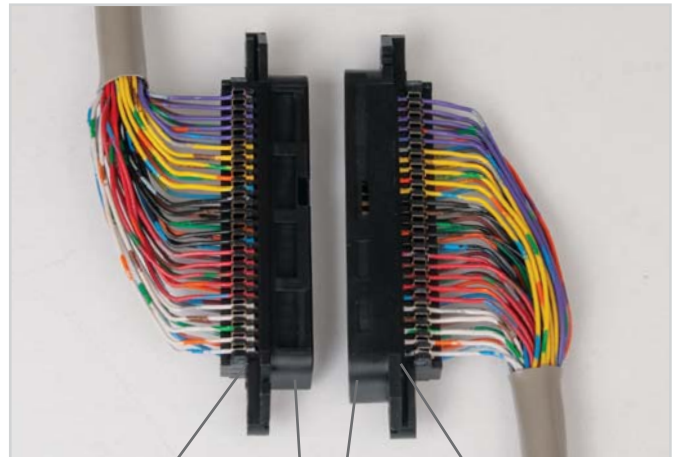

Inside view of Telco Connector with IDC Termination



Female Pin 1 Male

Hook and Loop Cable Tie Tape

- Continuous roll, cut to desired length

Description	Single Roll	10-Rolls
Economy hook and loop tape, 75' per roll, 0.5" W	ICACSQ75BK 	ICACSQVKBK 
Standard hook and loop tape, 75' per roll, 0.75" W [A]	ICACSV75xx*  	N/A

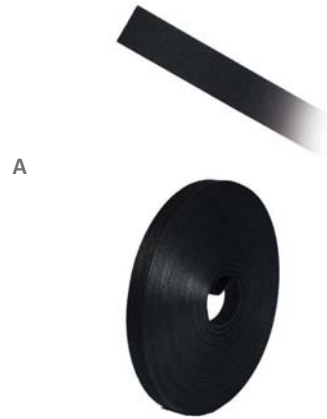

Hook and Loop Cable Tie Strap

- Individually perforated
- Economy straps are made from a thin material offering a low-cost cable management solution
- Standard straps are made from a thick material for heavy-duty applications

Description	Single Roll
Economy hook and loop pre-cut straps, 112-Pieces, 8" L, 0.5" W [B]	ICACSQB8BK 
Standard hook and loop pre-cut straps, 100-Pieces, 8" L, 0.5" W	ICACSVB8BK 
Standard hook and loop pre-cut straps, 100-Pieces, 12" L, 0.5" W	ICACSVBTBK 

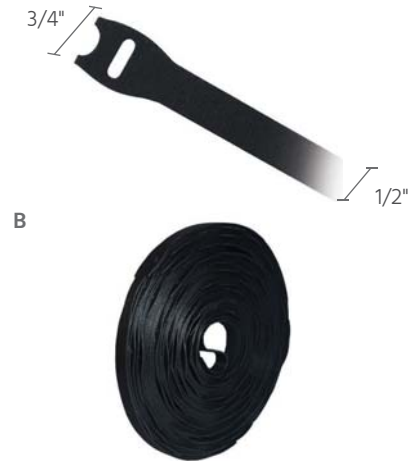

Modular Plugs

Description	Entry	Cable	AWG	100-Pack
CAT 6 with loading bar [C]	Oval	Solid/Stranded	23~24	ICMP8P8C6E
CAT 6/5e Shielded with loading bar [D]	Oval	Solid/Stranded	23~24	ICMP8P8C6S
CAT 5e with loading bar	Oval	Stranded	24~26	ICMP8P8C5E
8P8C	Oval	Solid	24~28	ICMP8P8SRD
8P8C	Oval	Stranded	24~28	ICMP8P8CRD
8P8C	Flat	Stranded	24~28	ICMP8P8CFT

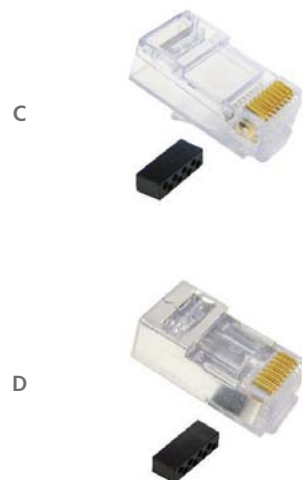

*Colors (xx):

	BL (Blue)		BK (Black)
--	--------------	--	---------------



Fiber Optic Systems

Enclosures	60-61
Adapter Panels	62-63
Patch Panels	62, 63, 65
MPO/MTP Cassettes	64-65
Patch Cords	65-66

Classic Enclosures



- LGX® compatible with many industry-standard platforms
- Can fit up to 72 fibers in one rack mount space

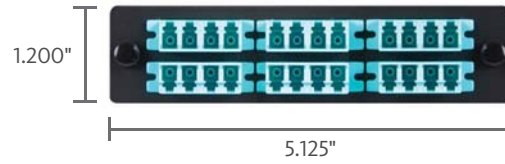
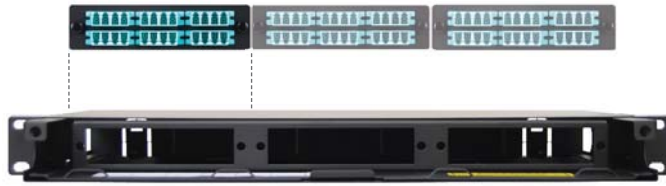

Rack Mount	Maximum Capacity				Single
	Fibers (Using LC)	Adapter Panels (LGX)	Splice Trays		
1 RMS [A]	72	3	2		ICFORE31RM
2 RMS [B]	144	6	3		ICFORE62RM
4 RMS	288	12	5		ICFORET4RM

- Removable front and rear covers and slide-out tray
- Includes cable management spools and hook-and-loop ties



Wall Mount	Maximum Capacity				Single
	Fibers (Using LC)	Adapter Panels (LGX)	Splice Trays		
Door with padlock option [C]	48	2	3		ICFODE21WM
Door with lock and key [D]	96	4	3		ICFODE41WM

- Built-in cable management spools and rubber grommets



HD Enclosures



- Works with HD adapter panels and cassettes with staggered push pins
- Can fit up to 96 fibers in one rack mount space

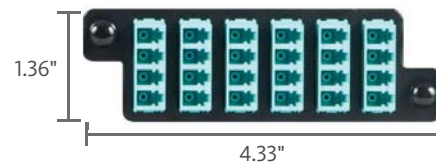

Rack Mount	Maximum Capacity			
	Fibers (Using LC)	Adapter Panels (HD)	Splice Trays	Single
1 RMS [A]	96	4	2	ICFORE41RM
2 RMS [B]	192	8	3	ICFORE82RM



- Removable front and rear covers and slide-out tray
- Includes cable management spools and hook-and-loop-ties

Wall Mount	Maximum Capacity			
	Fibers (Using LC)	Adapter Panels (HD)	Splice Trays	Single
Door with padlock option [C]	48	2	3	ICFODE21WH
Door with lock and key [D]	96	4	3	ICFODE41WH



- Built-in cable management spools and rubber grommets

Classic Patch Panel Bracket



Blank	Slots	Single
1 RMS	3	ICFORPP1RM



Classic Adapter Panels

LC-LC	24-Fiber	12-Fiber
Multimode, aqua	ICFOPL161G [A]	ICFOPL16BG [B]



Singlemode, blue	ICFOPL1619	ICFOPL16BK
------------------	------------	------------



Multimode, beige	ICFOPL1615	ICFOPL16B5
------------------	------------	------------

SC-SC	12-Fiber	6-Fiber
Multimode, aqua	ICFOPC161G [C]	N/A



Singlemode, blue	ICFOPC26BK	ICFOPS26BK [D]
------------------	------------	-----------------------



Multimode, beige	ICFOPC16BK	ICFOPS16BK
------------------	------------	------------

ST-ST	6-Fiber
Singlemode, blue [E]	ICFOPT26BK



Multimode, beige	ICFOPT16BK
------------------	------------

Blank	
Blank panel	ICFOPB00BK



Accessories

Fiber Optic	Kit
12-fiber splice tray [F]	ICFOSKFM12
24-fiber stackable splice tray	ICFOSTFP24



HD Patch Panel Bracket



Blank	Slots	Single
1 RMS	4	ICFORPP1RH



HD Adapter Panels

LC-LC	24-Fiber
Multimode, aqua [A]	ICFOPL16HG
Singlemode, blue [B]	ICFOPL16H9
Multimode, beige	ICFOPL16H5

SC-SC	12-Fiber
Multimode, aqua [C]	ICFOPC16HG
Singlemode, blue [D]	ICFOPC16H9
Multimode, beige	ICFOPC16H5

Blank	
Blank panel	ICFOPB00HK



HD Patch Panel

LC-LC	96-Fiber
Multimode, aqua, 1 RMS	ICFP96ML1G



Accessories

Fiber Optic	20-Pack
1 RMS, rubber grommet, 38.10mm [E]	ICFORECAC3
2 RMS, rubber grommet, 25.4mm	ICFORECAC2



20 Pack

Classic MPO Metal Cassettes



LC-MPO (MTP compatible)	2x12 Fiber MPO	1x12 Fiber MPO
OM3, Multimode, aqua	ICFC24ML1G [A]	ICFC12ML1G
OM2, Multimode, beige	ICFC24ML50	ICFC12ML50
OM1, Multimode, beige	ICFC24MLD6	ICFC12MLD6 [B]
OS2, Singlemode, blue	ICFC24SLD9	ICFC12SLD9

SC-MPO	1x12 Fiber MPO
OM3, Multimode, aqua [C]	ICFC12MS1G
OM2, Multimode, beige	ICFC12MS50
OM1, Multimode, beige	ICFC12MSD6
OS2, Singlemode, blue	ICFC12SSD9

HD MPO Metal Cassettes

LC-MPO	2x12 Fiber MPO
OM3, Multimode, aqua [D]	ICFC24MLHG
OM2, Multimode, beige	ICFC24MLH5
OM1, Multimode, beige	ICFC24MLH6
OS2, Singlemode, blue	ICFC24SLH9

SC-MPO	1x12 Fiber MPO
OM3, Multimode, aqua [E]	ICFC12MCHG
OM2, Multimode, beige	ICFC12MCH5
OM1, Multimode, beige	ICFC12MCH6
OS2, Singlemode, blue	ICFC12SCH9



Plug and Play MPO Plastic Cassettes



LC-MPO (MTP compatible)	2x12 Fiber MPO
OM3, Multimode, aqua [A]	ICFC24MLPG
OM2, Multimode, beige	ICFC24MLP5
OM1, Multimode, beige	ICFC24MLP6
OS2, Singlemode, blue	ICFC24SLP9
SC-MPO	1x12 Fiber MPO
OM3, Multimode, aqua	ICFC12MSPG
OM2, Multimode, beige [B]	ICFC12MSP5
OM1, Multimode, beige	ICFC12MSP6
OS2, Singlemode, blue	ICFC12SSP9

A



B



Plug and Play Patch Panel Bracket

Blank Panel	Slots
1 RMS, 19" width	IC107PPC04



MTP® Patch Cords, OFNP

Fiber Type	12 Fibers
OM3, Multimode Type A (1 to 1) (female)	ICFOJATGzz* [C]
OM3, Multimode Type B (1 to 12) (female)	ICFOJARGzz**
OS2, Singlemode Type A (1 to 1) (female)	ICFOJATSzz* [D]
OS2, Singlemode Type B (1 to 12) (female)	ICFOJARSzz**
OM4, Multimode Type A (1 to 1) (female)	ICFOJATQzz**
OM4, Multimode Type B (1 to 12) (female)	ICFOJARQzz*

C



D



*Lengths (zz) = 05, 10, 15, 20, 30, 40, 50, 60, 70, 80, 90, and 100 meters

**Lengths (zz)= 05, 10, 15, and 20 meters

Duplex Patch Cords, OFNR

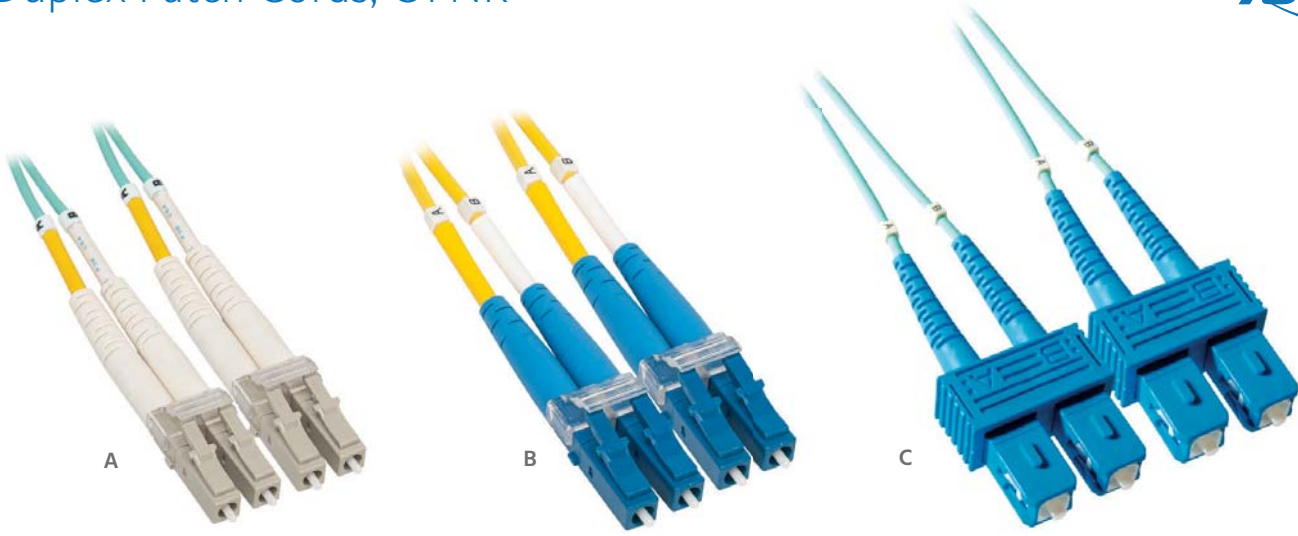

Fiber Type	OM3 50/125	OM2 50/125	OM1 62.5/125	OS2 9/125
LC to LC, 1.2" min. Bend Radius	ICFOJ1G7zz* [A]	ICFOJ1M7zz*	ICFOJ1M3zz*	ICFOJ1M5zz* [B]
LC to SC, 1.2" min. Bend Radius	ICFOJ2G7zz*	ICFOJ2M7zz*	ICFOJ2M3zz*	ICFOJ2M5zz*
LC to ST, 1.2" min. Bend Radius	N/A	ICFOJ3M7zz*	ICFOJ3M3zz*	ICFOJ3M5zz*
SC to SC, 1.2" min. Bend Radius	ICFOJ8G7zz* [C]	ICFOJ8C7zz*	ICFOJ8C3zz*	ICFOJ8C5zz*
SC to ST, 1.2" min. Bend Radius	N/A	ICFOJ9C7zz*	ICFOJ9C3zz*	ICFOJ9C5zz*
ST to ST, 1.2" min. Bend Radius	N/A	ICFOJ7C7zz*	ICFOJ7C3zz*	ICFOJ7C5zz*

*Lengths (zz) = 01, 02, 03, 05, 07, and 10 meters

LC Pigtail Packs for Splicing

- Individually color-coded pigtail fibers

Fiber Type	12 Fibers
OM3, LC, 900µ [D]	ICFOJSTGzz*
OS2, LC, 900µ	ICFOJSTSzz*

*Lengths (zz) = 01, 02, and 3 meters

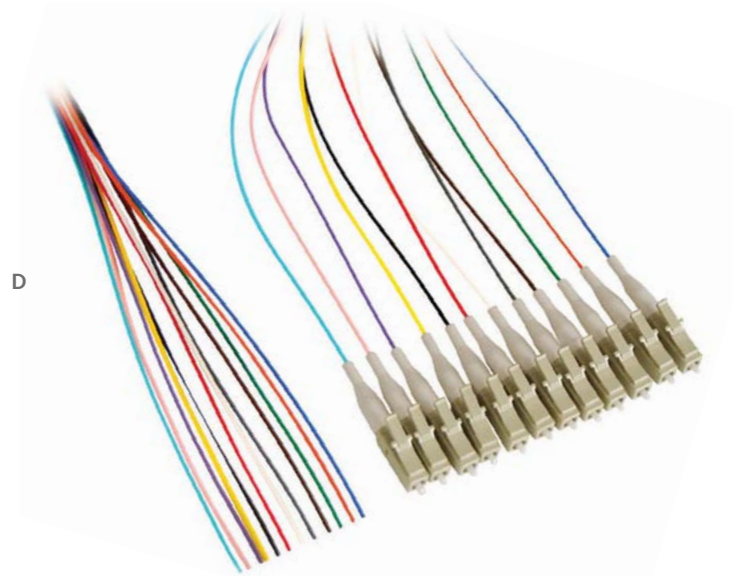



Cable Raceway

Sections
Fittings

68
69-70

Bulk Raceway, Priced Per Foot

- Permanent adhesive mounting
- One-piece design

Description	120 ft (6 ft x 20)
3/4" W, 6' L [A]	ICRWR11Sxx*
1-1/4" W, 6' L [B]	ICRWR12Sxx*
1-3/4" W, 6' L [C]	ICRWR13Sxx*

A

B

C

Description	160 ft (8 ft x 20)
3/4" W, 8' L	ICRWR118xx*
1-1/4" W, 8' L	ICRWR128xx*
1-3/4" W, 8' L	ICRWR138xx*

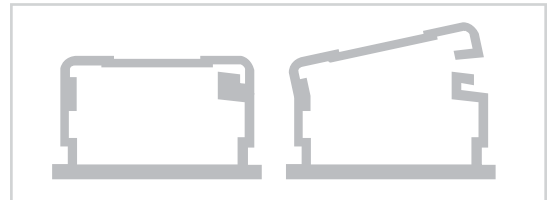

Front view of stick; product can be opened

Retail Raceway, Priced Per Stick

- Permanent adhesive mounting
- Individually packaged in a retail bag
- One-piece design

Description	20-Pack
3/4" W, 6' L [D]	ICRW22R6xx*
1-1/4" W, 6' L [E]	ICRW33R6xx*
1-3/4" W, 6' L [F]	ICRW44R6xx*

D

E

Description	20-Pack
3/4" W, 8' L	ICRW22R8xx*
1-1/4" W, 8' L	ICRW33R8xx*
1-3/4" W, 8' L	ICRW44R8xx*

F





20 Pack

*Colors (xx):



Outside Corner Covers









Description	10-Pack
3/4" [A]	ICRW110Cxx* 
1-1/4"	ICRW120Cxx* 
1-3/4"	ICRW130Cxx* 

A
 10 Pack









Inside Corner Covers

Description	Single	10-Pack
3/4" [B]	ICRW22NCxx* 	ICRW111Cxx* 
1-1/4"	ICRW33NCxx* 	ICRW121Cxx* 
1-3/4"	ICRW44NCWH 	ICRW131Cxx* 

B



Tees

Description	Single	10-Pack
3/4" [C]	ICRW22TExx* 	ICRW111TOxx* 
1-1/4"	ICRW33TExx* 	ICRW121TOxx* 
1-3/4"	ICRW44TExx* 	ICRW131TOxx* 

C



*Colors (xx):
 WH (White)
 IV (Ivory)

Ceiling Entries

Description	Single	10-Pack
3/4" [A]	ICRW22CMxx* 	ICRW11CExx*
1-1/4"	ICRW33CMxx* 	ICRW12CExx*
1-3/4"	ICRW44CMxx* 	ICRW13CExx*



Joint Covers

Description	Single	10-Pack
3/4" [B]	ICRW22JCxx* 	ICRW11JCxx*
1-1/4"	ICRW33JCxx* 	ICRW12JCxx*
1-3/4"	ICRW44JCxx* 	ICRW13JCxx*



90° Flat Elbows

Description	Single	10-Pack
3/4" [C]	ICRW22FExx* 	ICRW11EOxx*
1-1/4"	ICRW33FExx* 	ICRW12EOxx*
1-3/4"	ICRW44FExx* 	ICRW13EOxx*



End Caps

Description	Single	10-Pack
3/4" [D]	ICRW22ECxx* 	ICRW11ECxx*
1-1/4"	ICRW33ECxx* 	ICRW12ECxx*
1-3/4"	ICRW44ECWH 	ICRW13ECxx*



*Colors (xx): WH (White) IV (Ivory)



Punch Down Tools	72
Wire Cutters	73
Stripper Cable	73
Crimping Tools	74
Compression Tools	74

JackEasy™ 4-Pair Termination Tool



- Cuts four pairs of wires with one squeeze
- Works with HD and EZ® connectors
- Includes HD and EZ blades

Description	Single	6-Pack
Tool [A]	ICACSPDTEH	N/A
HD and EZ Replacement Blades [B]	ICACS8WUEH	N/A
HD Replacement Blade	N/A	ICACSPDRHD
EZ Replacement Blade	N/A	ICACSPDREZ



110 and 66 Single Blade Punch-Down Tool

- Includes 110 and 66 blades

Description	Single
Tool [C]	ICACSPDT00
110 Replacement Blade [D]	ICACS110RB
66 Replacement Blade [E]	ICACS066RB



110 4-Pair Punch-Down Tool

- 110 lbs. (50 kgs) maximum impact force

Description	Single
Tool [F]	ICACSPDT4P
Replacement Blade [G]	ICACS04PH5



Connector Removal Tool

- Helps remove keystone connectors and patch cords

Description	Single
Tool	ICACSP481



Handheld Termination Aid

- Works with HD and EZ connectors

Description	Single
Aid	ICACSHTA01



Stripper Tools

- Deluxe: strips UTP, STP, and coax cable
- Economy: strips UTP and STP cable
- 5~6.2mm cable diameter

Description	Single
Deluxe [A]	ICACSTSUCD
Economy [B]	ICACSTSUS1



Wire Cutter and Stripper

- Strips 12~24 AWG stranded wire and 10~22 AWG solid wire

Description	Single
Tool	ICACSTRST



Heavy Duty Modular Plug Crimping Tool

- Crimp 8-Position 8-Conductor modular plugs

Description	Single
Tool	ICACST845



Universal Modular Plug Crimping Tool

- Crimp 4, 6, and 8-Position modular plugs

Description	Single
Tool	ICACST864



Universal Compression Tool

- Compress F-Type, RCA, and BNC 90° compression connectors and modular compression connectors

Description	Single
Tool	ICACST01U



Economy Compression Tool

- Compress F-Type, RCA, and BNC compression connectors

Description	Single
Tool	ICACST01E



F-Type Connectors

- Works with the Universal and Compression tools

F-Type Connectors	100-Pack
RG-6, compression [A]	ICRDSAV01C
RG-6Q, compression	ICRDSAV04C
RG-59, compression	ICRDSAV59C

A



100 Pack

IC066BRCLP	28	IC107F3Cxx	10	IC107SF6SS	10	ICACSDCICL	22	ICCMSCMPB2	34
IC066CV050	28	IC107F3Txx	10	IC107ST2xx	6	ICACSDCVCL	22	ICCMSCMPB3	34
IC066DFT50	27	IC107F03xx	10	IC107UAAWH	8	ICACSHTA01	73	ICCMSCMPB4	34
IC066NB050	27	IC107F4Cxx	10	IC107UABWH	8	ICACSMBDxx	18	ICCMSCMPC1	34
IC066NBC50	27	IC107F4Txx	10	IC108SB1xx	14	ICACSMBSxx	18	ICCMSCMPC2	34
IC066SFT25	27	IC107F04xx	10	IC108SB2xx	14	ICACSPDREZ	72	ICCMSCMPK1	35
IC106FP2xx	13	IC107F5Cxx	2	IC108SB4xx	14	ICACSPDRHD	72	ICCMSCMPK2	35
IC107AHMWH	8	IC107F5Txx	2	IC108SB6xx	14	ICACSPDT00	72	ICCMSCMPLC	37
IC107AS4WH	13	IC107F6Cxx	2	IC110CB4PC	25	ICACSPDT4P	72	ICCMSCMPR5	37
IC107AUSWH	8	IC107F6Rxx	2	IC110CB5PC	25	ICACSPDTEH	72	ICCMSCMPR6	37
IC107B5Fxx	7	IC107F6Txx	2	IC110CMBNF	24	ICACSP481	73	ICCMSCMPR7	37
IC107B5Gxx	7	IC107F6Vxx	2	IC110CMBWF	24	ICACSQ75BK	58	ICCMSCMPT1	37
IC107B9Fxx	7	IC107F06xx	10	IC110H1004	24	ICACSQB8BK	58	ICCMSCMPT2	37
IC107B9Gxx	7	IC107F12xx	10	IC110LHLDR	25	ICACSQVKBK	58	ICCMSCMPV5	37
IC107BC1xx	14	IC107FD8xx	10	IC110NF100	24	ICACSS01BK	31	ICCMSCMPV6	37
IC107BC2xx	14	IC107FFWSS	11	IC110PRK61	25	ICACSTSUCD	73	ICCMSCMPV7	37
IC107BE241	21	IC107FFWxx	11	IC110RM100	25	ICACSTSUS1	73	ICCMSDRM02	37
IC107BFCWH	7	IC107FM3xx	12	IC110RM200	25	ICACSV75xx	58	ICCMSDRM03	37
IC107BFDWH	7	IC107FN4xx	12	IC110RMCMB	25	ICACSVB8BK	58	ICCMSDRM05	37
IC107BGCWH	7	IC107FQGWH	7	IC110TC450	25	ICACSVBTBK	58	ICCMSDRMC2	37
IC107BGDWH	7	IC107FT0WH	10	IC110W1004	24	ICACSWDS10	25	ICCMSDRMC3	37
IC107BN0xx	6	IC107FT4xx	12	IC110W3004	24	ICACSWDS20	25	ICCMSDRMC5	37
IC107BN2WH	6	IC107GACxx	3	IC110WF100	24	ICCABP5Exx	51	ICCMSDRPO2	37
IC107BNVxx	6	IC107GATxx	3	IC110WF300	24	ICCABP6Axx	51	ICCMSDRPO3	37
IC107BP8VB	22	IC107HDCWH	8	IC110WH100	24	ICCABP6Exx	51	ICCMSDRPO5	37
IC107BP12V	22	IC107HDMxx	8	IC110WK966	24	ICCABP6FBL	51	ICCMSCMPC3	34
IC107BP241	21	IC107HDTWH	8	IC625S51xx	15	ICCABP6Vxx	51	ICCMSHB1RC	30
IC107BP481	21	IC107L6Cxx	4	IC625S52xx	15	ICCABR5Exx	50	ICCMSHB1RS	30
IC107BP482	21	IC107L6Rxx	4	IC625SB6xx	15	ICCABR6Axx	50	ICCMSHB2RC	30
IC107C5CBK	6	IC107L6Txx	4	IC625SV11V	15	ICCABR6Exx	50	ICCMSHB2RS	30
IC107C5Exx	6	IC107L6Vxx	4	IC625SV2IV	15	ICCABR6FBL	50	ICCMSHB4RC	30
IC107C5TBK	6	IC107LC2xx	6	IC630DA6SS	16	ICCABR6Vxx	50	ICCMSHB4RS	30
IC107C6AS1	6	IC107LCGxx	6	IC630DB6xx	16	ICCABT5Exx	51	ICCMSHDS20	38
IC107C6Axx	6	IC107LF1xx	13	IC630DIBxx	11	ICCABT6Axx	51	ICCMCJH922	36
IC107C6CBK	6	IC107LF2xx	13	IC630E6GWH	17	ICCABT6Exx	51	ICCMCJH933	36
IC107C6Rxx	6	IC107LF3xx	13	IC630E0xx	17	ICCABT6FBL	51	ICCMCJH944	36
IC107C6Sxx	6	IC107LF6xx	13	IC630EB0xx	10	ICCABT6Vxx	51	ICCMCJH955	36
IC107C6TBK	6	IC107MB6BK	18	IC630EBDxx	10	ICCMSABR62	30	ICCMCJHB22	36
IC107CACBK	6	IC107MRDxx	18	IC630EBSSS	10	ICCMSABR64	30	ICCMCJHB33	36
IC107CATBK	6	IC107MRSxx	18	IC630EG0xx	17	ICCMSABR66	30	ICCMCJHB44	36
IC107CATS1	6	IC107PMGxx	7	IC640BDSxx	13	ICCMSABR68	30	ICCMCJHB55	36
IC107CP6xx	6	IC107PPC04	65	IC640BSSxx	13	ICCMSABRS2	30	ICCMCJHK22	36
IC107DA1xx	13	IC107PPS6A	21	IC1074Plxx	13	ICCMSABRS4	30	ICCMCJHK33	36
IC107DA2xx	13	IC107PPU6A	21	IC1075FTWH	7	ICCMSABRS6	30	ICCMCJHK44	36
IC107DA4xx	13	IC107S01SS	12	IC1076F0xx	2	ICCMSABRS8	30	ICCMCJHK55	36
IC107DDHxx	8	IC107S1TWH	12	IC1076FCxx	2	ICCMSABRSC	30	ICCMCJHW22	36
IC107DF4SS	10	IC107S01xx	12	IC1076FTxx	2	ICCMSC30BK	33	ICCMCJHW33	36
IC107DF8SS	10	IC107S02SS	12	IC1076V0xx	4	ICCMSC40BK	33	ICCMCJHW44	36
IC107DFDSS	11	IC107S2TWH	12	IC1076VCxx	4	ICCMSC42BK	33	ICCMCJHW55	36
IC107DFDxx	11	IC107S02xx	12	IC1076VTxx	4	ICCMSCMA15	34	ICCMCJHW55	36
IC107DFSxx	11	IC107S03SS	12	IC1078E5xx	4	ICCMSCMA25	34	ICCMSL4PBK	42
IC107DFTWH	11	IC107S03xx	12	IC1078F5xx	2	ICCMSCMA41	34	ICCMSLAWS2	41
IC107DH2xx	8	IC107S04SS	12	IC1078F6xx	2	ICCMSCMA42	34	ICCMSLCMRK	42
IC107DH1xx	11	IC107S04xx	12	IC1078GAXx	3	ICCMSCMA51	35	ICCMSLFT90	40
IC107DI2xx	11	IC107S06SS	12	IC1078L6xx	4	ICCMSCMA52	35	ICCMSLIR90	40
IC107DI3xx	11	IC107S06xx	12	IC1078S6A0	3	ICCMSCMA73	32	ICCMSLIRB01	42
IC107DI6xx	11	IC107SACA0	3	IC1079FTWH	7	ICCMSCMA81	32	ICCMSLMFF2	41
IC107DPIxx	13	IC107SAPxx	7	IC06626P4C	27	ICCMSCMA82	32	ICCMSLOR90	40
IC107DSBxx	7	IC107SATA0	3	IC06628P8C	27	ICCMSCMA83	32	ICCMSLPECK	42
IC107DSCxx	7	IC107SB1xx	14	IC06686P6C	27	ICCMSCMA84	32	ICCMSLRBSK	41
IC107E5Cxx	4	IC107SB2xx	14	ICACS04PH5	72	ICCMSCMAC1	34	ICCMSLRCRP	41
IC107E5Txx	4	IC107SB4WH	14	ICACS8WUEH	72	ICCMSCMAC2	34	ICCMSLRRBK	42
IC107F1Cxx	10	IC107SB6WH	14	ICACS066RB	72	ICCMSCMAV1	35	ICCMSLRRDB	41
IC107F1Txx	10	IC107SBTxx	14	ICACS110RB	72	ICCMSCMAV2	35	ICCMSLRW05	40
IC107F01xx	10	IC107SC2xx	6	ICACSCT01E	74	ICCMSCMP31	35	ICCMSLST05	40
IC107F02xx	10	IC107SF1SS	10	ICACSCT01U	74	ICCMSCMP32	35	ICCMSLSTV5	40
IC107F2Cxx	10	IC107SF2SS	10	ICACSCT845	74	ICCMSCMP61	35	ICCMSLSTV7	40
IC107F2Txx	10	IC107SF3SS	10	ICACSCT864	74	ICCMSCMP62	35	ICCMSLSTW5	40
IC107F02xx	10	IC107SF4SS	10	ICACSCTRST	73	ICCMSCMPB1	34	ICCMSLTJS6	42

ICCMSLTJSK.....42	ICFOJ2M7zz.....66	ICMPP12V60.....22	ICPCSP05xx.....55	ICRESDP14E.....44	ICRW44R8xx.....68
ICCMSLTWS6.....41	ICFOJ3M3zz.....66	ICMPP24CP5.....23	ICPCSP07xx.....55	ICRESDP14K.....44	ICRW44TExx.....69
ICCMSLVWBK.....42	ICFOJ3M5zz.....66	ICMPP24CP6.....23	ICPCSP10xx.....55	ICRESDP14W.....44	ICRW11Sxx.....68
ICCMSR4P84.....32	ICFOJ3M7zz.....66	ICMPP24CPA.....23	ICPCSP14xx.....55	ICRESDP28K.....44	ICRW12Sxx.....68
ICCMSR1972.....32	ICFOJ7C3zz.....66	ICMPP024T2.....26	ICPCSP25xx.....55	ICRESDPA2U.....47	ICRW13Sxx.....68
ICCMSR1984.....32	ICFOJ7C5zz.....66	ICMPP24T2C.....26	ICPCST01xx.....54	ICRESDPA2W.....47	ICRW118xx.....68
ICCMSRRCMC5.....34	ICFOJ7C7zz.....66	ICMPP024T4.....26	ICPCST03xx.....54	ICRESDPA1C.....46	ICRW128xx.....68
ICCMSRSDS20.....38	ICFOJ8C3zz.....66	ICMPP24T4C.....26	ICPCST05xx.....54	ICRESDPA3C.....46	ICRW138xx.....68
ICCMSRSDSC3.....38	ICFOJ8C5zz.....66	ICMPP24TF2.....26	ICPCST07xx.....54	ICRESDPA3D.....46	
ICCMSRSDV20.....39	ICFOJ8C7zz.....66	ICMPP24TF4.....26	ICPCST10xx.....54	ICRESDPB1C.....46	
ICCMSRSDV30.....39	ICFOJ8G7zz.....66	ICMPP024U6.....20	ICPCST14xx.....54	ICRESDPB2U.....47	
ICCMSRSDVC4.....39	ICFOJ9C3zz.....66	ICMPP25CMB.....20	ICPCST25xx.....54	ICRESDPB2W.....47	
ICCMSRFLKT.....32	ICFOJ9C5zz.....66	ICMPP48C51.....23	ICPCSTFBzz.....57	ICRESDPB3C.....46	
ICCMSRKSMT.....38	ICFOJ9C7zz.....66	ICMPP48C61.....23	ICPCSTFFzz.....57	ICRESDPB3D.....46	
ICCMSRMU1C.....37	ICFOJARGzz.....65	ICMPP48CP5.....23	ICPCSTFMzz.....57	ICRESDR9PH.....44	
ICCMSRSF10.....38	ICFOJARQzz.....65	ICMPP48CP6.....23	ICPCSTMBzz.....57	ICRESDR14H.....48	
ICCMSRSF15.....38	ICFOJARSzz.....65	ICMPP48CPA.....23	ICPCSTMMzz.....57	ICRESDR14T.....48	
ICCMSRSFC1.....38	ICFOJATGzz.....65	ICMPP048T2.....26	ICPCSV01xx.....55	ICRESDR21H.....48	
ICCMSRSFC2.....38	ICFOJATQzz.....65	ICMPP48T2C.....26	ICPCSV03xx.....55	ICRESDR28H.....48	
ICCMSRSV10.....39	ICFOJATSzz.....65	ICMPP48TF2.....26	ICPCSV05xx.....55	ICRESVPA1C.....46	
ICCMSRSV15.....39	ICFOJSTGzz.....66	ICMPP048U6.....20	ICPCSV07xx.....55	ICRESVPA2U.....47	
ICCMSRSVC1.....39	ICFOJSTSzz.....66	ICMPP125EV.....22	ICPCSV10xx.....55	ICRESVPA2W.....47	
ICCMSRSVC2.....39	ICFOPB00BK.....62	ICMPP0245E.....20	ICPCSW01xx.....54	ICRESVPA3C.....46	
ICCMSSSF12.....31	ICFOPB00HK.....63	ICMPP245EV.....20	ICPCSW03xx.....54	ICRESVPA3D.....46	
ICCMSSSF25.....31	ICFOPC16BK.....62	ICMPP246AS.....21	ICPCSW05xx.....54	ICRESVPB1C.....46	
ICCMSWMMR08.....31	ICFOPC16H5.....63	ICMPP246AU.....21	ICPCSW07xx.....54	ICRESVPB3C.....46	
ICCMSWMMR15.....31	ICFOPC16H9.....63	ICMPP0246B.....20	ICPCSW10xx.....54	ICRW11CExx.....70	
ICCMSWMMR30.....31	ICFOPC16HG.....63	ICMPP0485E.....20	ICPCSX01xx.....54	ICRW11ECxx.....70	
ICCMSWMSV2.....39	ICFOPC26BK.....62	ICMPP485EV.....20	ICPCSX03xx.....54	ICRW11EOxx.....70	
ICCMSWMMUR5.....31	ICFOPC161G.....62	ICMPP0486B.....20	ICPCSX05xx.....54	ICRW11ICxx.....69	
ICFC12MCH5.....64	ICFOPL16B5.....62	ICMPP1260V.....22	ICPCSX07xx.....54	ICRW11JCxx.....70	
ICFC12MCH6.....64	ICFOPL16BG.....62	ICMPP02460.....20	ICPCSX10xx.....54	ICRW11OCxx.....69	
ICFC12MCHG.....64	ICFOPL16BK.....62	ICMPP2460V.....20	ICPCSY01xx.....55	ICRW11TOxx.....69	
ICFC12ML1G.....64	ICFOPL16H5.....63	ICMPP04860.....20	ICPCSY03xx.....55	ICRW12CExx.....70	
ICFC12ML50.....64	ICFOPL16H9.....63	ICMPP4860V.....20	ICPCSY05xx.....55	ICRW12ECxx.....70	
ICFC12MLD6.....64	ICFOPL16HG.....63	ICMPPMB506.....18	ICPCSY07xx.....55	ICRW12EOxx.....70	
ICFC12MS1G.....64	ICFOPL161G.....62	ICMPPMB606.....18	ICPCSY10xx.....55	ICRW12ICxx.....69	
ICFC12MS50.....64	ICFOPL1615.....62	ICMPPTF242.....26	ICRDS0F5WH.....17	ICRW12JCxx.....70	
ICFC12MSD6.....64	ICFOPL1619.....62	ICMPPTF244.....26	ICRDSAV01C.....74	ICRW12OCxx.....69	
ICFC12MSP5.....65	ICFOPS16BK.....62	ICPCSF01BL.....54	ICRDSAV04C.....74	ICRW12TOxx.....69	
ICFC12MSP6.....65	ICFOPS26BK.....62	ICPCSF03BL.....54	ICRDSAV59C.....74	ICRW13CExx.....70	
ICFC12MSPG.....65	ICFOPT16BK.....62	ICPCSF05BL.....54	ICRSDC2LK.....48	ICRW13ECxx.....70	
ICFC12SCH9.....64	ICFOPT26BK.....62	ICPCSF07BL.....54	ICRSDCAC2.....48	ICRW13EOxx.....70	
ICFC12SLD9.....64	ICFORE31RM.....60	ICPCSF10BL.....54	ICRDSMMAW8.....45	ICRW13ICxx.....69	
ICFC12SSD9.....64	ICFORE41RM.....61	ICPCSG03xx.....54	ICRDSMMBK1.....45	ICRW13JCxx.....70	
ICFC12SSP9.....65	ICFORE62RM.....60	ICPCSG05xx.....54	ICRDSMMBW1.....45	ICRW13OCxx.....69	
ICFC24ML1G.....64	ICFORE82RM.....61	ICPCSG07xx.....54	ICRDSMMBW8.....45	ICRW13TOxx.....69	
ICFC24ML50.....64	ICFORECAC2.....63	ICPCSG10xx.....54	ICRDSV05WH.....17	ICRW22CMxx.....70	
ICFC24MLD6.....64	ICFORECAC3.....63	ICPCSG15xx.....54	ICRDSVF5WH.....17	ICRW22ECxx.....70	
ICFC24MLH5.....64	ICFORET4RM.....60	ICPCSG25xx.....54	ICRES8V42S.....47	ICRW22FExx.....70	
ICFC24MLH6.....64	ICFORPP1RH.....63	ICPCSH01xx.....55	ICRES8V62S.....47	ICRW22JCxx.....70	
ICFC24MLHG.....64	ICFORPP1RM.....62	ICPCSH03xx.....55	ICRES8V82S.....47	ICRW22NCxx.....69	
ICFC24MLP5.....65	ICFOSKFM12.....62	ICPCSH05xx.....55	ICRESAV42L.....47	ICRW22R6xx.....68	
ICFC24MLP6.....65	ICFP96ML1G.....63	ICPCSH07xx.....55	ICRESAV62L.....47	ICRW22R8xx.....68	
ICFC24MLPG.....65	ICMAGBLOCK.....18	ICPCSH10xx.....55	ICRESAV62V.....47	ICRW22TExx.....69	
ICFC24SLD9.....64	ICMB89B0WH.....28	ICPCSH15xx.....55	ICRESAV82L.....47	ICRW33CMxx.....70	
ICFC24SLH9.....64	ICMB89BCWH.....28	ICPCSH20xx.....55	ICRESBMP04.....47	ICRW33ECxx.....70	
ICFC24SLP9.....65	ICMB89D0WH.....28	ICPCSM01BL.....55	ICRESBMP06.....47	ICRW33FExx.....70	
ICFODE21WH.....61	ICMB89U0WH.....28	ICPCSM03BL.....55	ICRESCM06.....48	ICRW33JCxx.....70	
ICFODE21WM.....60	ICMP8P8C5E.....58	ICPCSM05BL.....55	ICRESDC9PK.....44	ICRW33NCxx.....69	
ICFODE41WH.....61	ICMP8P8C6E.....58	ICPCSM07BL.....55	ICRESDC9PW.....44	ICRW33R6xx.....68	
ICFODE41WM.....60	ICMP8P8C6S.....58	ICPCSM10BL.....55	ICRESDC14K.....45	ICRW33R8xx.....68	
ICFOJ1G7zz.....66	ICMP8P8CFT.....58	ICPCSN01BL.....55	ICRESDC14W.....45	ICRW33TExx.....69	
ICFOJ1M3zz.....66	ICMP8P8CRD.....58	ICPCSN03BL.....55	ICRESDC21E.....45	ICRW44CMxx.....70	
ICFOJ1M5zz.....66	ICMP8P8SRD.....58	ICPCSN05BL.....55	ICRESDC21K.....45	ICRW44ECWH.....70	
ICFOJ1M7zz.....66	ICMPP12F5E.....22	ICPCSN07BL.....55	ICRESDC28E.....45	ICRW44FExx.....70	
ICFOJ2G7zz.....66	ICMPP12F6E.....22	ICPCSN10BL.....55	ICRESDC28K.....45	ICRW44JCxx.....70	
ICFOJ2M3zz.....66	ICMPP012U6.....22	ICPCSP01xx.....55	ICRESDCAC3.....48	ICRW44NCWH.....69	
ICFOJ2M5zz.....66	ICMPP12V5E.....22	ICPCSP03xx.....55	ICRESDCBUM.....48	ICRW44R6xx.....68	

Elite Installer Program

The Elite Installer Program is a reseller program that aims to build a strong partnership and loyalty between Installers and ICC. By joining as an Elite Installer, your company can enjoy exclusive benefits directly from ICC for using ICC products. Additionally, as a Certified Elite Installer with a Master Technician, your company can offer a Lifetime Performance Warranty with your cabling installations.

Elite Installer™

- Free membership
- 15-Year Performance Limited Warranty
- Project discounts
- Sales promotions
- Free product samples and demos
- New product releases
- Reward points

Certified Elite Installer™

- Paid membership
- All benefits from Elite, plus:
- Lifetime Performance Limited Warranty
- One free Master Technician Training Course included
- Free unlimited site verifications
- Free tools

Master Technician Training

- One-day course
- Earn a Master Technician License
- BICSI® certified
- Earn BICSI Continuing Education Credits
- Hands-on training

Visit icc.com/elite to learn more and sign up.





Extended Warranties

ICC manufactures its products with the highest level of quality and adheres to strict industry standards. That's why we can offer our Installers comprehensive performance warranties for full system coverage.

Lifetime Performance Warranty™

The warranty is exclusively available through ICC Certified Elite Installers and covers the guaranteed performance of the entire system for the usable life of the cable system. The coverage includes the replacement of ICC products and the labor needed to replace them. To be eligible, the cabling system must be installed by a Certified Elite Installer using ICC category-rated connectivity products and ICC horizontal premise cable as an end-to-end Permanent Link solution. Additionally, the cabling system must be verified as a Verified Site Cabling System.



15-Year Performance Warranty™

The warranty is exclusively available through ICC Elite Installers and covers the guaranteed performance of the entire system from end-to-end for 15 years from the date of installation. The coverage includes the replacement of ICC products only. To offer this warranty to your customers, you can sign up as an Elite Installer; no certification or training is required.



Visit icc.com/warranty for more information.

Elite Installer™ Success Stories

Our Elite Installers have completed projects in a wide range of industries, including:

School districts

University campuses

Residential tract homes

Apartment complexes

Medical facilities

Hotels and resorts

Government buildings

Retail stores

Commercial buildings

Community centers

Visit icc.com/success to read more success stories from ICC Elite Installers.

Disclaimer

The information contained in this catalog is believed to be accurate and reliable but is subject to change without notice. The publisher of this catalog does not assume any responsibility for any errors or omissions in the information contained herein. All prices are subject to change without notice. The publisher of this catalog makes no representations or warranties, express or implied, as to the accuracy or completeness of the information contained herein, and specifically disclaims all warranties of merchantability and fitness for a particular purpose. The publisher of this catalog shall not be liable for any damages whatsoever arising out of the use of or reliance upon the information contained herein.



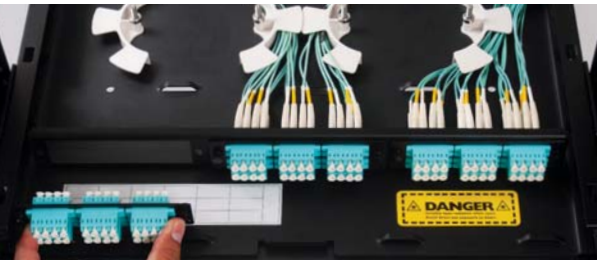
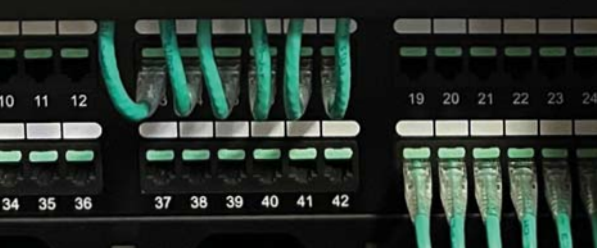

Copper | Fiber

Commercial | Residential

Structured Cabling Solutions



📍 California, USA

🌐 ICC.COM

MMILIT0448-23