

# Voice & Visual Communication Solutions



*Page Number*

|   |       |   |
|---|-------|---|
| Who we are... What we do.....                                     | 2-5   | ■ |
| Analog/SIP Paging Design.....                                     | 6-7   | ■ |
| Analog Page Controls.....   | 8     | ■ |
| SIP Paging.....   | 9     | ■ |
| Ceiling Speakers.....   | 10-12 | ■ |
| Signature Series High-Fidelity Speakers.....                      | 13    | ■ |
| Wall Speakers.....  | 14-16 | ■ |
| Vandal-Resistant Speakers.....                                    | 17    | ■ |
| Horns.....  | 18-19 | ■ |
| Power Supplies.....   | 20    | ■ |
| Intercom/Door Entry.....  | 21    | ■ |
| Enhancements <i>Spot SoundMasking, Call Buttons, Sounds</i> ..... | 22    | ■ |
| Enhancements <i>Microphones, Paging Expansion</i> .....           | 23    | ■ |
| Enhancements <i>Managing Sound, Feedback, MOH</i> .....           | 24    | ■ |
| Enhancements <i>Tones, LED Signs</i> .....                        | 25    | ■ |
| Dial Select Intercoms <i>DualPath, MultiPath</i> .....            | 26-27 | ■ |
| Valcom SIP HelpPoints.....  | 28-29 | ■ |
| Clocks <i>IP PoE Clocks, Wireless, Wired</i> .....                | 30    | ■ |
| Clocks <i>Controls, Drivers &amp; Accessories</i> .....           | 31    | ■ |
| Clock/Speakers <i>Assemblies</i> .....                            | 31-32 | ■ |
| Engineered Solutions.....   | 33    | ■ |
| Index - <i>Descriptive</i> .....                                  | 34-37 | ■ |
| Index - <i>Numerical</i> .....                                    | 38-39 | ■ |

# Who we are . . . what we do . . .

*From Start to Finish  
All Under One Roof:*

**Design**

**Engineering**

**Manufacturing**

**Product Testing**

**Quality Control**

**Marketing/Sales**

**Shipping**

**Technical Support**



*At Valcom, we realize each project is customer specific. For this reason, we will continue to listen to our customers to provide the highest quality solutions.*

### ***Proudly Made In The USA for Over 35 Years***

Valcom, the largest provider of telephone integrated paging systems in the world, knows and understands customer needs.

For over 35 years, our focus has always been, and will continue to be, listening to and providing customer based solutions.

Valcom's unique and extensive experience in IP and Analog Voice Paging Systems, Mass Notification, IP Centric Multimodal Systems and Telecommunication Enhancements gives us a unique perspective. We are well known for providing guidance and assistance in implementing everything from the simplest paging system to the most complex mass notification solution. Our customer base includes most of the Fortune 500 companies, the majority of highly secure US Government facilities, local government emergency service organizations, over 35,000 schools and quite possibly your own organization.

Virtually all of Valcom's products are engineered, manufactured and supported in our 120,000 square foot state-of-the-art facility in Roanoke, Virginia, USA. Valcom's component products are available through wholesale distributors and integrators.

Valcom has some of the industry's newest and most innovative manufacturing processes and works continuously to improve our customer solutions.



# Our Markets



## K12

### *District*

- Centralized Mass Notification
- Integrates w/ Legacy Intercom Systems
- Centralized Bell Scheduling & Clocks
- Remote Maintenance

### *Schools*

- IP & Analog Intercom
- Clock Bell Scheduling Systems
- Door Entry
- Visual Notification-ADA
- Lockdown Systems

### *Classrooms*

- Emergency Help Buttons
- Classroom Amplification
- Wireless Panic Buttons
- A/V Device Audio Management



## Higher Education

### *University/College*

### *Community College*

### *MultiCampus*

- Easy Button Mass Notification
- Emergency Telephones
- Visual Notification Systems
- SMS/Text/Dialog System
- IP Emergency Speaker/Button
- IP Dorm Room Emergency Calling



## Commercial/Industrial

### *Manufacturing*

### *Office Complexes*

### *Retail • Distribution*

- Voice Paging
- Tones for Shift Changes, Breaks, Lunch
- Mass Notification
- Background Music
- Emergency Telephones
- Building or Enterprise Wide



## Government/Military

### *City Facilities • Police*

### *Fire/Rescue Facilities*

### *City-Wide Emergency Telephones*

- City-Wide or Campus-Wide
- Mass Notification
- Suitable for Government Networks
- Synchronized Clocks
- IP Fire/Rescue Paging/Intercom
- Emergency Telephones
- IPAWS – WEMA - CAP



## Health Care

### *Hospitals • Clinics • Extended Care*

- Hospital Enterprise Voice Paging with Automated Announcements and Text-to-Speech
- IP Centric - Manage Existing Paging Assets
- Reconfigure Zone Groups Software
- Mass Notification – Voice & Visual Alerting
- Synchronized Clocks
- Emergency Telephones
- Noise Masking - Select Areas - HIPAA



## Transportation

### *Airports • Transit*

### *Parking Lots*

- Terminal Paging
- Mass Notification
- Crash Rescue Intercoms
- Emergency Telephones
- Visual Notification Systems
- Synchronized Clocks



### Loudspeaker Paging

- Find People When Not at Their Desk
- Reduces Call Back Times
- Increase Safety & Security
- Notify Everyone for Quick Evacuation
- Single or Multizone, All Call & Group Call
- Talkback Paging
- Override Access
- Door Entry/Security Management
- Background Music



### Intercoms

*VoIP Based and Analog – Two-Way*

#### Common Applications:

- School Intercoms
- Warehouse Intercoms
- Airport Crash Rescue Emergency Intercoms
- Dormitory and Assisted Living Facilities
- Two-Way Communication in Hospital O.R. & Laboratories
- Door-Entry Applications



### Mass Notification Systems

*Multimodal IP Centric*

- Mass Notification Solutions for Education, Healthcare, Industrial, etc.
- Simple or Complex Audio/Visual Multimodal Solutions
- Supervised



### Synchronized Clock Systems

*Wired, Wireless, and IP*

- Synchronized
- Analog Clocks
- Digital Clocks
- Clock Speaker Combinations



### IP Emergency Telephones

*Pedestal/Stanchion Blue Light*

- IP Emergency Telephones are PoE – Eliminate Need for External Power
- Dual Function Capability – Call-In and Emergency Broadcast
- Retrofit Existing Stanchions
- Options: Fiber, Wireless, Solar, Cameras
- Supervised



### Emergency Message Signs

*PoE*

- Optional Add-On for Certain IP Speakers
- Stand Alone Message Signs
- Speaker Add-On's for Stand-Alone Signs

# Loudspeaker Paging

Distributed Amplified Analog Technology  
or IP Technology

One-Way Paging System  
or Talkback Intercom System

Visual Notification Signs  
or Silent Bell Notifications

## Analog Paging

### What is Distributed Amplified Analog Technology?

Designed specifically to take advantage of in-place wiring — each one-way paging speaker provides a built-in amplifier and volume control. These speakers are essentially independent public address systems that can be networked together using standard telephone/datacom low voltage wiring (CAT 5/6) that allows easy system configuration and flexible modification as customer needs change.

Valcom offers significantly higher system efficiency and superior response by optimizing each amplifier/speaker combination. Utilizing high-efficiency American made speaker components eliminates transformer power losses. The net result is a reduction in cost, power dissipation and a dramatic increase in system efficiency and reliability due to the inherent system redundancy.

## Valcom's Easy 1-2-3 System Design

### Step 1 Select a Page Control



Page Controls are the "Brain" of the system and are specifically designed for telephone system integration. Systems are easily field expandable and/or upgradable to allow for future adds, moves and changes.

### Step 2 Select Speakers & Horns



Speakers are generally used for interior environments and provide high-quality music and voice reproduction.



Horn speakers offer high-efficiency, rugged construction and superb voice quality. They're typically used outdoors or in loud, industrial or harsh interior areas.

### Step 3 Select a Power Supply



Built-in power is often included in the page control so an additional power supply may not be needed. The amount of power required for a paging system is based on the quantity and type of page control and speakers/horns selected.

Valcom Products are Assigned Valcom Power Units (VPU)

Products Either **Provide + #** or **Consume - #** Power

Specific details for determining power are on page 20.



**Clock Systems  
or Schedule Management**

**Need Secure Systems  
or Tie All Systems Together**

**System Enhancements:  
Eliminate Feedback, Tones, Mics**

# SIP Paging

**Paging over LAN/WAN with no limits on distance.**

Easily add speakers or audio gateways anywhere on your network:

- In other buildings
- Detached warehouses regardless of location
- Used car lot that is two blocks away
- Detached trailer buildings
- Any campus location
- Each of your retail stores across the nation

Valcom IP Public Address is intended to distribute audio via IP protocol over vast distances via wired networks, fiber optic networks or even wirelessly.

It enables you to address, inform and alert large groups of people: customers, employees and visitors in public spaces.

The major advantage of IP public address systems is its usage in installations where it is difficult and expensive or even impossible to run cabling.

**Leverage your installed PA system: Simply Plug and Page.**

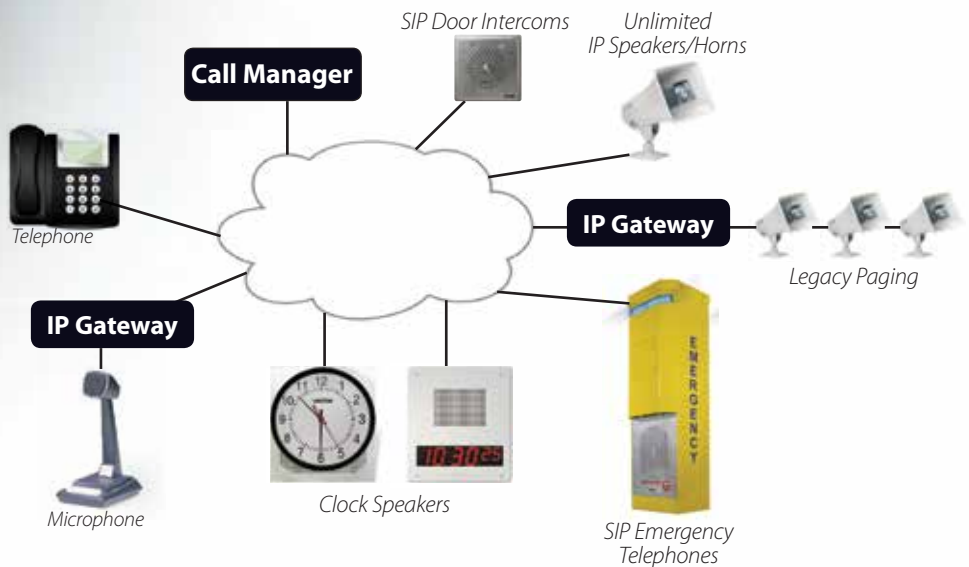

# Analog Page Controls



| <b>Analog 2000 Series™</b> |  | VPU |
|----------------------------|--|-----|
| <b>A</b>                   | <b>1 Zone</b> ♦♦▲<br>• Basic Zone or Area of Paging<br>One-Way..... V-2000A +12<br>2.60"H x 7.70"W x 5.30"D (6.60cm x 19.56cm x 13.46cm) 2.6lbs (1.2kg)  |     |
| <b>B</b>                   | <b>1 Zone Enhanced</b> ♦♦▲<br>• Phantom Zone™ Allows Paging to All Speakers But Limits Music to Selected Speakers<br>One-Way..... V-2001A +20<br>One-Way European Version*..... V-2001A-E +20<br>7.10"H x 9.00"W x 2.40"D (18.03cm x 22.86cm x 6.10cm) 3.7lbs (1.68kg)<br>*International Version - Power Requirements: 230 Vac/5A  |     |
| <b>C</b>                   | <b>3 Zones</b> ♦♦▲<br>• Three Zones of One-Way Paging Plus All Call<br>One-Way..... V-2003A +20<br>7.10"H x 10.00"W x 3.00"D (18.03cm x 25.40cm x 7.62cm) 4.1lbs (1.86kg)<br>One-Way European Version*..... V-2003A-E +20<br>7.10"H x 10.00"W x 3.00"D (18.16cm x 25.40cm x 7.62cm) 4.1lbs (1.86kg)<br>Talkback..... V-2003AHF +10<br>7.10"H x 10.00"W x 3.00"D (18.03cm x 25.40cm x 7.62cm) 5.6lbs (2.54kg)<br>Talkback European Version*..... V-2003AHF-E +10<br>7.10"H x 10.00"W x 3.00"D (18.16cm x 25.40cm x 7.62cm) 5.6lbs (2.54kg)<br>*International Version - Power Requirements: 230 Vac/5A                             |     |
| <b>D</b>                   | <b>6 Zones</b> ♦♦▲<br>• Six Zones of One-Way Paging, All Call, 3 Programmable Zone Groups<br>One-Way..... V-2006A +30<br>10.90"H x 13.00"W x 2.70"D (27.69cm x 33.20cm x 6.86cm) 6.2lbs (2.81kg)<br>One-Way European Version*..... V-2006A-E +30<br>10.90"H x 13.00"W x 2.70"D (27.69cm x 33.20cm x 6.86cm) 6.2lbs (2.81kg)<br>Talkback..... V-2006AHF +20<br>10.90"H x 13.00"W x 2.70"D (27.69cm x 33.20cm x 6.86cm) 7.5lbs (3.40kg)<br>Talkback European Version*..... V-2006AHF-E +20<br>10.90"H x 13.00"W x 2.70"D (27.69cm x 33.20cm x 6.86cm) 7.5lbs (3.40kg)<br>*International Version - Power Requirements: 230 Vac/1.0A |     |

| <b>Analog Page Controls</b>   |  | VPU |
|---|--|-----|
| <i>PBX Loop Start Trunk, Electronic Key Line, Single Line Phone</i> |  |     |
| <b>E</b>  | <b>1 Zone</b> ♦<br>Talkback ..... V-9941A -6<br>8.25"H x 4.65"W x 2.30"D (20.96cm x 11.81cm x 5.84cm) 1.5lbs (0.68kg)                |     |
| <i>Station Level/FXS Adapters</i>                                   |  |     |
| <b>1 Zone</b> ●   |  |     |
| <b>F</b>  | For use with One-Way Controllers..... V-9970 -4<br>8.25"H x 4.50"W x 2.35"D (20.96cm x 11.43cm x 5.97cm) 1.5lbs (0.68kg)             |     |
| <b>G</b>  | For use with One-Way or Talkback Controllers..... V-9940 -4<br>8.20"H x 4.55"W x 2.30"D (20.83cm x 11.56cm x 5.84cm) 1.7lbs (0.77kg) |     |
| <b>H</b>  | PagePal Interface ♦♦▲●..... V-5335700 0<br>2.50"H x 6.00"W x 4.00"D (6.35cm x 15.24cm x 10.16cm) 2.0lbs (0.91kg)                     |     |

## What is a Zone?

A zone can be any area, any size that you determine. It's usually an area where the same overhead pages would need to be heard.

Within a zone you can have as many different types of speakers as you want. From basic overhead round ceiling speakers, to high-fidelity sound, to horns for water-proof areas, to door entry speakers and many more.



## Step 1 Select a Page Control

### Easy Selection Considerations:

- Number of Zones
- One-Way Broadcast Only or Talkback (Includes One-Way) Two-Way HandsFree
- Special Features

| Model #                     | One-Way Page Controls |   |         |            | Talkback Page Controls |            |
|-----------------------------|-----------------------|---|---------|------------|------------------------|------------|
|                             | V-2000A               | V-2001A   | V-2003A | V-2006A    | V-2003AHF              | V-2006AHF  |
| Number of Zones             | 1                     | 1   | 3       | 6          | 3                      | 6          |
| Background Music            | •                     | •   | •       | •          | •                      | •          |
| All Call                    | •                     | •   | •       | •          | •                      | •          |
| Group Call                  |                       |   |         | •          |                        | •          |
| Emergency Page Override     |                       | •   | •       | •          | •                      | •          |
| Night Ring/Time Clock Tones |                       | •   | •       | •          | •                      | •          |
| Valcom Power Units Provided | + 12                  | + 20  | + 20    | + 30       | + 10                   | + 20       |
| Telephone Access            | FXO<br>Port           | PBX Loop Start Trunk Port   | ♦       |            |                        |            |
|                             |                       | Electronic Key Line Position  | ■       |            |                        |            |
|                             |                       | Dedicated Single Line Phone Set   | ▲       |            |                        |            |
|                             |                       | PBX Ground Start Trunk Port   | ■       |            |                        |            |
|                             |                       | Page Port (Telephone System Dependant)                                  | ▲       |            |                        |            |
|                             |                       | Centrex or C.O. Line PBX Analog Station Port (Loop Disconnect Required) | ●       |            |                        |            |
|                             |                       |   |         | Use V-9970 | Use V-9970             | Add V-9940 |

Look for these orange symbols when selecting page controls



## SIP Connection To Self-Amplified Speakers, IP Speakers or Legacy 25/70 Volt Amps

The Analog outputs on the VIP-201A and VIP-204A allow you to connect to modern self-amplified speakers or to legacy central amplified systems. The analog zones can be dialed individually or grouped. Multiple VIP-20x units can be used to give an infinite number of zones.

- Feedback Elimination Function
- SIP Night Ring Function
- SIP Loud Ringer Function
- On premise or hosted IP Telephone Systems

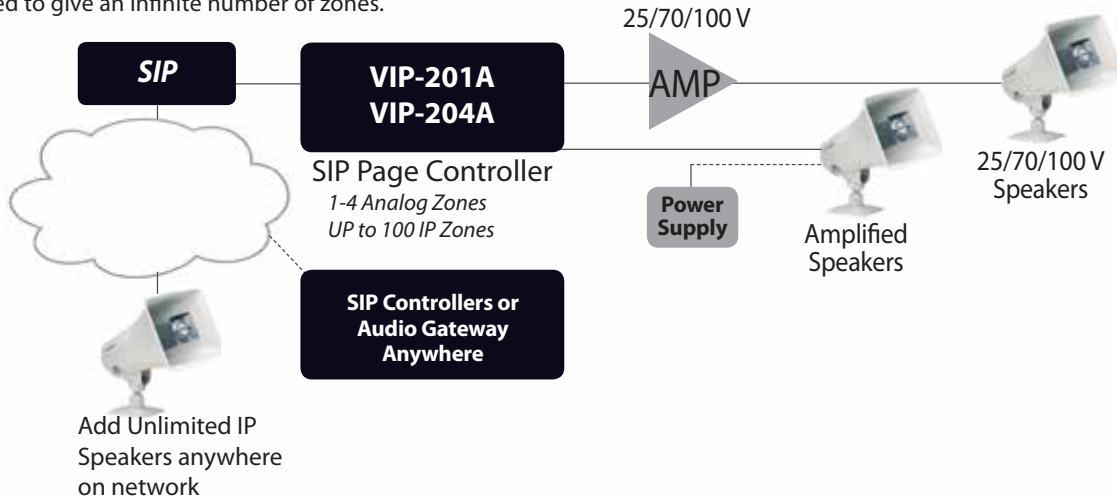

## Existing Legacy Multi-Zone Paging

The VIP-821A allows for a SIP connection to a legacy multizone intercom or paging system. This is of great benefit to customers who have moved from a traditional analog PBX to an IP telephone system. Simply take the existing FXO port connection and connect it to the line port on the VIP-821A.

- Replaces Existing Wired FXO Connection
- Perfect for Any IP Telephone System
- Works with Hosted IP Telephone Systems

Plug the VIP-821A into a PoE port on the network and register it as a 3rd party SIP identity to your IP telephone system. The customer then dials the SIP identity of the VIP-821A. The VIP-821A comes off hook and draws dial-tone from the existing intercom or paging system. No reprogramming or retraining is required.

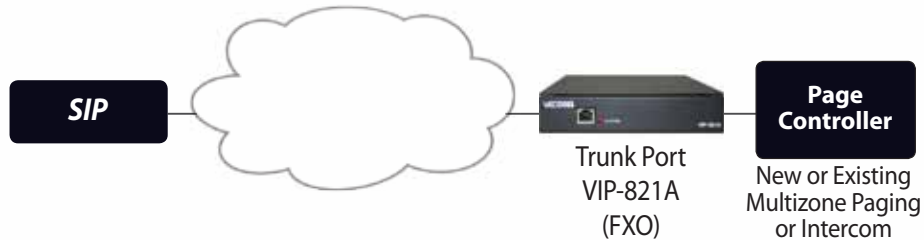

**1 Zone of One-Way Analog Paging Plus 8 Zones SIP Station or 100 Zones SIP Trunk** ..... VIP-201A

- 1 Analog Audio Output
- 1 AUX Audio Input
- 2 Programmable Form C Relay Closures

**4 Zones of One-Way Analog Paging Plus 8 Zones SIP Station or 100 Zones SIP Trunk** ..... VIP-204A

- 4 Analog Audio Output
- 1 AUX Audio Input
- 4 Programmable Form A Relay Closures



**SIP 20W Gateway 25V** ..... VIP-851-25

**SIP 20W Gateway 25/70/100V** ..... VIP-851-70/100



**Audio Ports** (Line Level -10dbm)

**1 Audio Port** ..... VIP-801A

- 1 Audio Output & Input
- 1 Contact Closure Input
- 2 Programmable Form C Relay Contacts

**InformaCast®** ..... VIP-801A-IC

**2 Audio Ports** ..... VIP-802A

- 2 Audio Outputs & Inputs
- 2 Contact Closure Inputs
- 2 Programmable Form A Relay Contacts

**4 Audio Ports** ..... VIP-804A

- 4 Audio Outputs & Inputs
- 4 Contact Closure Inputs
- 4 Programmable Form A Relay Contacts



**FXS Ports** (Station Ports)

**1 FXS Port** ..... VIP-811A

- 1 RJ-11 FXS Port
- 2 Programmable Form C Relay Contacts

**2 FXS Ports** ..... VIP-812A

- 2 RJ-11 FXS's
- 4 Programmable Form C Relay Contacts

**4 FXS Ports** ..... VIP-814A

- 4 RJ-11 FXS's
- 4 Programmable Form C Relay Contacts



**FXO Ports** (Loop Start)

**1 FXO Port** ..... VIP-821A

- 1 RJ-11 FXO
- 1 RJ-11 Telephone Failover Connection

**2 FXO Ports** ..... VIP-822A

- 2 RJ-11 FXO's
- 2 RJ-11 Telephone Failover Connections

**4 FXO Ports** ..... VIP-824A

- 4 RJ-11 FXO's
- 4 RJ-11 Telephone Failover Connections

# Ceiling Speakers



**Fastest and Easiest**  
Speaker to Install!

| Analog Lay-In Ceiling Speakers  |   | IP SoundPoints® |  |
|---|---|-----------------|--|
| A   | <b>2' x 2'</b><br>Colors: White (Paintable), Custom Colors-CC           | VPU             |  |
|   | <b>One-Way (2 Pack)</b> 5.8lbs (2.63kg) ..... V-9022A-2                 | ①               |  |
|   | <b>One-Way European Ver.</b> 5.8lbs (2.63kg) ..... V-9022-EC            | ①               |  |
|   | <b>One-Way Dual-Input</b> 5.8lbs (2.63kg) ..... V-9028                  | ①               |  |
|   | <b>IP One-Way SECURE</b> 5.5lbs (2.49kg) ..... VIP-402A                 |                 |  |
|   | <b>IP One-Way SECURE InformaCast®</b> 5.8lbs (2.63kg) ..... VIP-402A-IC |                 |  |
|   | <b>IP One-Way European Version</b> 5.5lbs (2.49kg) ..... VIP-402A-EC    |                 |  |
|   | <b>Talkback</b> 5.5lbs (2.49kg) ..... V-9062                            | ②               |  |
| B   | <b>1' x 2'</b><br>Colors: White (Paintable), Custom Colors-CC           |                 |  |
|   | <b>One-Way</b> ..... V-9021   | ①               |  |
|   | 11.75"L x 23.75"W x 3.75"D (29.85cm x 60.33cm x 9.53cm) 4.7lbs (2.13kg) |                 |  |
|   | <b>Talkback</b> 5.5lbs (2.49kg) ..... VIP-422A                          |                 |  |
|   | <b>IP Talkback, InformaCast®</b> 5.5lbs (2.49kg) ..... VIP-422A-IC      |                 |  |
| U.S. Version: 23.75"L x 23.75"W x 3.75"D (60.33cm x 60.33cm x 9.53cm) |   |                 |  |
| European Version: 600mm x 600mm                                       |   |                 |  |

## Lay-In Ceiling Speakers™

Easy Lay-In Installation Replaces a 2' x 2' Tile

- Save Time, Effort & Money  
- Get On & Off the Job Quickly
- No Cutting Tiles, No Broken Tiles, No Mess
- Lightweight - Weighs Slightly More Than a 2' x 2' Ceiling Tile
- Includes Integral Backbox that Meets/Exceeds ASTM E84 Flame & Smoke Test w/3 Hour Burn Rating

### Accessory:

**Trim T-Bar (10 Pack)** ..... V-TBAR  
24.5"L x 1.0"W x 1.0"D (62.23cm x 2.54cm x 2.54cm) 3.5 lbs (1.58 kg)

## Step 2 Select Speakers & Horns

### Easy Selection Considerations:

- Style, Decor & Color
- Indoor, Outdoor or Industrial Environments
- One-Way or Talkback
- Area to be Paged in Square Feet
- Determine Ceiling Heights & Type
- Noise Levels

### Speaker / Horn Placement Guide

|                                   |   | Shows SPACE Between Horns & Square Foot Coverage PER Horn |                        |                      |                               |                      |        |        |        |
|-----------------------------------|---|---|------------------------|----------------------|-------------------------------|----------------------|--------|--------|--------|
|                                   |   | Quiet<br>50-65dB  | Moderate<br>65-80dB    | Noisy<br>80-90dB     | Very Noisy<br>90+dB           |                      |        |        |        |
| Speakers                          | Ceiling Height x 2 = Speaker Placement<br>Example:<br>8' Ceiling x 2 = Space Speakers 16' Apart |   |                        |                      |                               |                      |        |        |        |
|                                   | Wall Speaker Placement<br>Spaced 20' Apart (One Per 600 sq. ft.)                                |   |                        |                      |                               |                      |        |        |        |
|                                   | Horns   |   |                        |                      |                               |                      |        |        |        |
|                                   |   | 5-Watt  | 110'<br>(12,000sq.ft.) | 80'<br>(6,400sq.ft.) | 50'<br>(2,500sq.ft.)          | 30'<br>(900sq.ft.)   |        |        |        |
|                                   |   | 15-Watt   | -                      | -                    | 75'<br>(5,600sq.ft.)          | 45'<br>(2,000sq.ft.) |        |        |        |
|                                   |   | 30-Watt   | -                      | -                    | -                             | 60'<br>(3,600sq.ft.) |        |        |        |
| Power Pair Run                    |   |   |                        |                      |                               |                      |        |        |        |
| # of Speakers/Horns Per Power Run |   |   |                        |                      | Power Run Wire Length in Feet |                      |        |        |        |
| # Interior Speakers               | Signature Series™   | Flex Horns  | 5-Watt Horns           | 15/30-Watt Horns     | 24 AWG                        | 22 AWG               | 20 AWG | 18 AWG | 16 AWG |
| 4                                 | 1   | -   | -                      | -                    | 1000'                         | 1600'                | 2500'  | 4000'  | 6400'  |
| 7                                 | 2   | 1   | 1                      | -                    | 500'                          | 800'                 | 1280'  | 2025'  | 3220'  |
| 15                                | 4   | 2   | 2                      | -                    | 250'                          | 400'                 | 640'   | 1010'  | 1610'  |
| 30                                | 8   | 4   | 4                      | 1                    | 125'                          | 200'                 | 320'   | 500'   | 805'   |

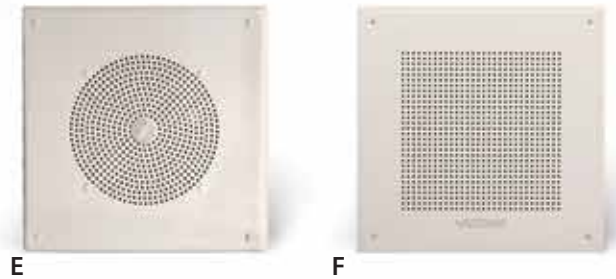
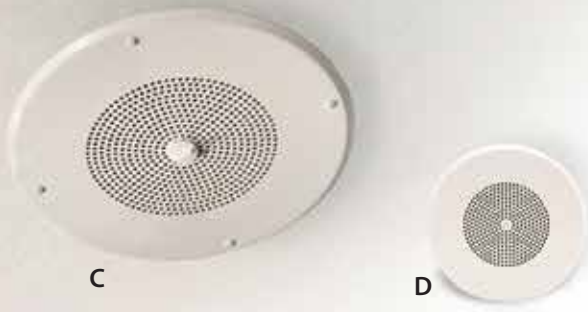

**C&D**  
**Round Ceiling Speakers**

*Exceptional Voice & Music Reproduction*

- Contains Its Own Built-In Amplifier
- White Epoxy Finish
- “Pop-On/Pop-Off” Volume Control Knob
- Screwdriver Adjustable Volume Control in Front
- Available In Custom Colors
- Optional Bridges and Backboxes Below

**Accessories: Mounting Hardware** M=Metal, P=Plastic

**Large Round Ceiling Speaker:**

- Speaker Bridge (5 Pack)** ..... V-9914M-5
- Pre-Construction Bridge (10 Pack)** ..... V-9912M-10
- Post-Const. Mounting Ring (12 Pack)**..... V-9912P-12
- Backbox (5 Pack)** ..... V-9915M-5
- Bridge/Backbox Combo**..... V-9916M

**Small Round Ceiling Speaker:**

- Speaker Bridge (5 Pack)** ..... V-9904M-5
- Backbox (5 Pack)** ..... V-9915M-5



*Must Use V-9904M-5 Bridge & V-9915M-5 Backbox Together for Combo  
See Website for Measurements*



**E&F**  
**Square Ceiling Speakers**

- Excellent Voice and Music Reproduction
- Wide Sound Dispersion
- Electrically, Acoustically Matched Components
- Sturdy Steel Grille

**Accessories: Optional Backboxes**

- Surface Mount** ..... VB-S11   
11.63”H x 11.63”W x 3.94”D
- Recessed Mount** ..... VB-R12   
10.75”H x 10.75”W x 3.94”D
- Angled Mount** ..... VB-A13   
11.63”H x 11.63”W x 4.60”D[t] x 3.15”D[b]

| Analog Round Ceiling Speakers |  | IP SoundPoints® |
|-------------------------------|--|-----------------|
| C                             | <b>Large Round</b><br><i>Colors: White (Paintable), Custom Colors -CC</i>  | VPU             |
|                               | <b>One-Way SECURE</b> ..... V-1020C -1                                     |                 |
|                               | <b>IP One-Way SECURE</b> ..... VIP-120A                                    |                 |
|                               | 13.0”Dia x 3.0”D (33.02cm x 7.62cm) 2.5lbs (1.13kg)                        |                 |
|                               | <b>IP One-Way SECURE InformaCast®</b><br>2.5lbs (1.13kg) ..... VIP-120A-IC |                 |
| D                             | <b>Small Round</b><br><i>Colors: White (Paintable), Custom Colors -CC</i>  |                 |
|                               | <b>One-Way</b> 1.7lbs (0.77kg) ..... V-1010C -1                            |                 |
|                               | 7.65”Dia x 2.9”D (19.43cm x 7.37cm)  |                 |
|                               | <b>IP Talkback</b> ..... V-1060A 0 ..... VIP-160A                          |                 |
|                               | <b>IP Talkback InformaCast®</b> ..... VIP-160A-IC                          |                 |

| Analog Square Ceiling Speakers |  | IP SoundPoints® |
|--------------------------------|--|-----------------|
| E                              | <b>Square Ceiling (Round Hole Pattern)</b><br><i>Colors: White (Paintable), Custom Colors -CC</i>  | VPU             |
|                                | <b>One-Way</b> ..... V-1920C -1  |                 |
|                                | <b>“Pop-On/Pop-Off” Volume Control</b>   |                 |
|                                | <b>Talkback (6 Pack)</b> ..... V-CTSQPK 0  |                 |
| F                              | <b>Square Ceiling (Square Hole Pattern)</b><br><i>Colors: White (Paintable), Custom Colors -CC</i> |                 |
|                                | <b>One-Way</b> ..... V-1921 -1   |                 |
|                                | <b>IP One-Way or Talkback Programmable</b> ..... VIP-428A  |                 |
|                                | <b>IP One-Way, InformaCast®</b> ..... VIP-418A-IC  |                 |
|                                | <b>Talkback</b> ..... V-1961 0   |                 |
|                                | <b>IP Talkback, InformaCast®</b> ..... VIP-428A-IC   |                 |

# Ceiling Speakers



## Fast Installation

*Quick to Relocate!*

### A P-Tec™ Ceiling Speaker

*Easy Push/Lock Speaker Installs in Tile Ceilings*

- Great for Open Offices Where Speaker Relocation is Made Easier
- Side Dispersion Angle
- Lightweight, Easy to Mount and Move



### B Pendant Speakers

*Great for High Ceilings*

*Ideal for: Retail, Restaurant, Office, Hallway, and Covered Patios*

- High-Efficiency Speaker
- Metal, Weather-Resistant Enclosure
- Simply Hang from Included Six Foot Chain *Black*



► **Accessory:** *Optional*

**Additional Six Foot Chain** ..... V-1093BK

### C Clean Room Speaker

*Designed for Applications Where Concentration of Airborne Particles is Controlled. For Pharmaceutical, Medical & Other Critical Manufacturing Environments*

- Large Rubber O-Ring to Seal the Grille to the Ceiling
- Rubber Washers for All Mounting Hardware
- Polycarbonate Dust Shield Between Speaker & Grille



### D Surface Mount Ceiling Vandal-Resistant Speaker

*Ideal for Concrete Ceilings & Harsh Areas: Correctional Institutions, Outside Entrances, Industrial*

- Tapered Exterior, Heavy-Gauge Steel Construction
- Steel-Mesh Security Screen Prevents Objects from Penetrating Speaker
- Tamper-Resistant Screws Resist Removal
- White Epoxy Finish, Available in Custom Colors



| Analog Ceiling Speakers |  | IP SoundPoints® |  |
|-------------------------|--|-----------------|--|
| <b>A</b>                | <b>P-Tec™</b><br>Color: White<br><b>One-Way</b> ..... V-1001<br><b>Talkback</b> ..... V-1070<br>8.0"Dia x 2.5"H (20.32cm x 6.35cm) 0.75lbs (.34kg)   | VPU             |  |
|                         |  | - 1             |  |
|                         |  | 0               |  |
| <b>B</b>                | <b>Pendant</b><br>Colors: Black -BK, Gray -GY, White -W, Custom Colors -CC<br><b>One-Way Black Grill</b> ..... V-1015B<br><b>One-Way White with White Grill</b> . . .V-1015B-WW<br>5.8"Dia x 8.8"H (14.73cm x 22.35cm) 3.2lbs (1.45kg) |                 |  |
|                         |  | - 6             |  |
|                         |  | - 6             |  |
| <b>C</b>                | <b>Clean Room</b><br>Color: White<br><b>One-Way</b> ..... V-1040<br><b>IP One-Way or Talkback Programmable</b> ..... VIP-140A<br>13"Dia x 3.0"D (33.02cm x 7.62cm) 2.5lbs (1.13kg)   |                 |  |
|                         |  | - 1             |  |
| <b>D</b>                | <b>Surface Mount</b><br>Colors: White (Paintable), Custom Colors -CC<br><b>One-Way</b> ..... V-9010-W<br>8.5"Dia x 5.1"D (21.59cm x 12.95cm) 4.8lbs (2.18kg)   |                 |  |
|                         |  | - 1             |  |



## E Signature Series™ Lay-In Ceiling Speaker™

Easy Lay-In Installation Replaces a 2' x 2' Tile

- Save Time, Effort & Money - Get On & Off the Job Quickly
- No Cutting Tiles, No Broken Tiles, No Mess
- Lightweight - Weighs Slightly More Than a 2' x 2' Ceiling Tile
- Includes Integral Backbox that Meets/Exceeds ASTM E84 Flame & Smoke Test w/3 Hour Burn Rating
- White Epoxy Finish, Available in Custom Colors

### Accessory:

- Use to Install in a 2' x 4' Ceiling Tile
- Trim T-Bar** (10 Pack) ..... V-TBAR



## F Signature Series™ Ceiling

For Premium Music Applications

- Exceptional Frequency Response for Voice And Music Reproduction
- "Pop-On/Pop-Off" Volume Control Knob
- White Epoxy Finish, Available in Custom Colors

### Accessory: Optional

- Speaker Mounting Hardware:** M=Metal
- HiFi Bridge & Backbox** ..... V-9816M



## G Signature Series™ Monitor

- Easy Install Shelf Mount or Wall Mount w/Optional Mounting Bracket
- Colors: Black, White and Custom Colors



### Accessory: Optional

**Optional Wall Mounting Bracket** ..... V-9804  
5.8"H x 2.75"W x 2.05"D (14.73cm x 6.99cm x 5.21cm) 0.7lbs (0.32kg)

**Wire Cage** (2 Pack) ..... V-WGWALL-2  
12"H x 16.5"W x 5.5"D (30.5cm x 41.9cm x 14.0cm) 2.35lbs (1.1kg)

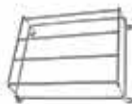

## H Signature Series™ In-Wall

- Simply Recess in a Wall
- White Epoxy Finish



The Very Best In Music Quality!



| Analog High-Fidelity Speakers |   | VPU |
|-------------------------------|---|-----|
| <b>E</b>                      | <b>Signature Series™ Lay-In</b><br>Colors: White (Paintable), Custom Colors -CC<br><b>One-Way</b> 5.5lbs (2.49kg) ..... V-1422<br>23.75"L x 23.75"W x 3.75"D (60.33cm x 60.33cm x 9.53cm)   | -4  |
| <b>F</b>                      | <b>Signature Series™ Ceiling</b><br>Colors: White (Paintable), Custom Colors -CC<br><b>One-Way</b> ..... V-1420<br>13"Dia x 3.0"D (33.02cm x 7.62cm) 3.5lbs (1.59kg)                        | -4  |
| <b>G</b>                      | <b>Signature Series™ Monitor</b><br>Colors: Black -BK, White -W, Custom Colors -CC<br><b>One-Way</b> ..... V-1440<br>7.00"H x 10.3"W x 4.70"D (17.78cm x 26.16cm x 11.94cm) 5.2lbs (2.36kg) | -4  |
| <b>H</b>                      | <b>Signature Series™ In-Wall</b><br>Colors: White<br><b>One-Way</b> ..... V-1450<br>12.00"H x 8.65"W x 3.20"D (30.48cm x 21.97cm x 8.13cm) 3lbs (1.36kg)                                    | -4  |

# Wall Speakers



## A Slimline™

**Modern & Affordable!**

**Ideal for Offices, Clinics, Retail, Dentist Waiting Rooms & Schools**

- Excellent Voice & Music Quality *Good Looking ... Good Sounding ...*
- Easy Install - Simply Hang On a Single Screw or Use the 2 Screw Bosses

**Accessory:** *Optional*

**Wire Cage** (2 Pack) ..... V-WGWALL-2  
 12"H x 16.5"W x 5.5"D (30.5cm x 41.9cm x 14.0cm) 2.35lbs (1.1kg)

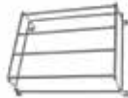

## B Desktop/Wall

**Reach People While They're On The Phone!**

- Self-Standing - Rubber Feet Prevent Movement on a Desk Surface
- Mount on a Wall as a Mini-Speaker  
 - Front Cover may be Rotated to Match Positioning on Wall
- Off-Hook Voice Announce with Handsfree Reply
- Volume Adjusted with Knob on Front
- Talkback Push Button Model Available
- IP Version Available - Call Valcom

## C Track-Style

**Ideal for Retail, Restaurants, Offices, Hallways & Covered Patios**

- High-Efficiency Speaker
- Metal, Weather-Resistant Enclosure
- Attach Track Bracket to a Wall or Exposed Beam
- Colors: Black, White and Custom Colors
- Externally Accessible Volume Control  
 Screwdriver Adjustable Through Hole in Grille

| <b>Analog Wall Speakers</b>                                      |  |     |
|--|--|-----|
| <b>A Slimline™</b>   |  | VPU |
| <i>Colors: Black -BK, Gray -GY, White -W, Custom Colors -CC</i>  |  |     |
| <b>One-Way</b> 2.8lbs (1.27kg)..... V-1042                       |  | -1  |
| <i>Colors: Black -BK and Custom Colors -CC</i>                   |  |     |
| <b>Talkback</b> 2.7lbs (1.22kg) ..... V-1046                     |  | 0   |
| 7.0"H x 10.3"W x 3.4"D (17.78cm x 26.16cm x 8.64cm)              |  |     |
| <b>Accessory:</b> <i>Optional</i>                                |  |     |
| <b>Wire Cage</b> (2 Pack) ..... V-WGWALL-2                       |  |     |
| 12"H x 14.5"W x 5.5"D (30.5cm x 41.9cm x 14.0cm) 2.35lbs (1.1kg) |  |     |
| <b>B Desktop/Wall</b>  |  |     |
| <i>Colors: Black -BK, Gray -GY, White -W</i>                     |  |     |
| <b>One-Way</b> 0.6lbs (0.27kg)..... V-763                        |  | -1  |
| <b>Talkback</b> 0.7lbs (0.32kg) ..... V-762                      |  | 0   |
| <b>Talkback w/Push Button</b> 0.7lbs (0.32kg)..... V-764         |  | 0   |
| 3.9"H x 5.1"W x 3.2"D (9.91cm x 12.95cm x 8.13cm)                |  |     |
| <b>C Track-Style</b>   |  |     |
| <i>Colors: Black -BK, White -W and Custom Colors -CC</i>         |  |     |
| <b>1-Watt</b>  |  |     |
| <b>One-Way</b> Black Grill ..... V-1013B                         |  | -1  |
| <b>One-Way</b> White with White Grill ..... V-1013B-WW           |  | -1  |
| 5.8"Dia x 8.8"H (14.73cm x 22.35cm) 2.5lbs (1.13kg)              |  |     |
| <b>5-Watt</b>  |  |     |
| <b>One-Way</b> Black Grill ..... V-1014B                         |  | -6  |
| 5.8"Dia x 8.8"H (14.73cm x 22.35cm) 3.1lbs (1.41kg)              |  |     |



| Analog Metal Wall Speakers  |     | IP SoundPoints® |  |
|---|-----|-----------------|--|
| <b>D Metal Wall</b><br><i>Colors: Gray, (Paintable), Custom Colors -CC</i>          | VPU |                 |  |
| One-Way ..... V-1052C   | ①   | VIP-430A        |  |
| IP One-Way or Talkback Programmable.....  |     | VIP-410A-IC     |  |
| IP One-Way, InformaCast®.....   |     | VIP-430A-IC     |  |
| Talkback..... V-1071  | ②   |                 |  |
| IP Talkback, InformaCast®.....  |     | VIP-430A-IC     |  |
| 10.13"H x 12.31"W x 4.63"D (25.73cm x 31.27cm x 11.75cm)<br>4.25lbs (1.91kg)        |     |                 |  |
| <b>Accessory: Optional</b>  |     |                 |  |
| Wire Cage (2 Pack)..... V-WGWALL-2  |     |                 |  |
| 12"H x 14.5"W x 5.5"D (30.5cm x 41.9cm x 14.0cm)<br>2.35lbs (1.1kg)                 |     |                 |  |
| <b>E Metal Corner</b><br><i>Colors: Gray, (Paintable), Custom Colors -CC</i>        |     |                 |  |
| One-Way ..... V-1054  | ①   |                 |  |
| Talkback..... V-1055  | ②   |                 |  |
| 10"H x 12"W x 4.5"D (25.4cm x 30.48cm x 11.43cm)<br>3.0lbs (1.36kg)                 |     |                 |  |
| <b>F Square Wall Speaker</b><br><i>Colors: White (Paintable), Custom Colors -CC</i> |     |                 |  |
| One-Way ..... V-1921  | ①   | VIP-428A        |  |
| IP One-Way or Talkback Programmable.....  |     | VIP-418A-IC     |  |
| IP One-Way, InformaCast®.....   |     | VIP-428A-IC     |  |
| Talkback..... V-1961  | ②   |                 |  |
| IP Talkback, InformaCast®.....  |     | VIP-428A-IC     |  |
| 11.5"H x 11.5"W x 4.00"D (29.21cm x 29.21cm x 10.2cm) 4.0lbs (1.81kg)               |     |                 |  |

### D Metal Wall

- Gray with Black Cloth Grille
- Steel with a Durable Powder Coated Gray Finish
- Easily Match any Decor by Changing Color of Enclosure
- Easy Installation - Screw Terminal Connection
- Excellent Voice and Music Reproduction

**Accessory: Optional**

Wire Cage (2 Pack) ..... V-WGWALL-2  
12"H x 16.5"W x 5.5"D (30.5cm x 41.9cm x 14.0cm) 2.35lbs (1.1kg)

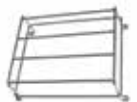

### E Metal Wall Corner

- Corner Speaker is Mounting Up Near Ceiling to Allow for Easy Wire Connection
- 8-Inch Speaker
- Paintable Metal Housing (Black Cloth Grille)
- Easy Installation - Screw Terminal Connection
- Excellent Voice and Music Reproduction

### F Square Wall Speaker

- Line Output Supports Valcom Amplified Speakers
- White Paintable Metal

**Backboxes: Optional**

Surface Mount ..... VB-S11  
11.63"H x 11.63"W x 3.94"D



Recessed Mount ..... VB-R12  
10.75"H x 10.75"W x 3.94"D



Angled Mount ..... VB-A13  
11.63"H x 11.63"W x 4.60"D[t] x 3.15"D[b]



# Wall Speakers



A



B



C

D



E

| Analog Light Woodgrain Wall <i>Open-Weave Grille</i> |  | VPU |
|--|--|-----|
| A  | <b>Angled Wall</b>   |     |
|  | <b>One-Way</b> ..... V-1022C   | -1  |
|  | 10.75"H x 9.75"W x 5.0"D [t], 3.75"D [b] (27.31cm x 24.77cm x 12.70cm [t], 9.53cm [b]) 4.5lbs (2.03kg) |     |
|  | <b>One-Way, Dual-Input</b> ..... V-1222  | -1  |
|  | 10.75"H x 9.75"W x 5.0"D [t], 3.75"D [b] (27.31cm x 24.77cm x 12.70cm [t], 9.53cm [b]) 4.5lbs (2.03kg) |     |
| B  | <b>Bi-Directional Corridor</b>   |     |
|  | <b>One-Way</b> ..... V-1026C   | -1  |
|  | 10.3"H x 10.3"W x 4.2"D (26.2cm x 26.2cm x 10.7cm) 5.6lbs (2.54kg)                                     |     |

| Analog Black & White Wall            |   | VPU |
|--------------------------------------|---|-----|
| <b>Black</b>                         |   |     |
| C                                    | <b>One-Way</b> ..... V-1016-BK  | -1  |
|                                      | 9.7"H x 11.5"W x 4.0"D (24.6cm x 29.2cm x 10.16cm) 4.1lbs (1.86kg)    |     |
|                                      | <b>Talkback</b> ..... V-1061-BK                                       | 0   |
|                                      | 9.6"H x 11.5"W x 4.2"D (24.38cm x 29.21cm x 10.67cm) 4.0lbs (1.81kg)  |     |
| <b>White</b>                         |   |     |
| D                                    | <b>One-Way</b> ..... V-1016-W   | -1  |
|                                      | 9.7"H x 11.5"W x 4.0"D (24.6cm x 29.2cm x 10.16cm) 4.1lbs (1.86kg)    |     |
|                                      | <b>Talkback</b> ..... V-1061-W  | 0   |
|                                      | 9.6"H x 11.5"W x 4.2"D (24.38cm x 29.21cm x 10.67cm) 4.0lbs (1.81kg)  |     |
| <b>White Bi-Directional Corridor</b> |   |     |
| E                                    | <b>One-Way</b> ..... V-1026C-W  | -1  |
|                                      | 10.3"H x 10.3"W x 4.2"D (26.2cm x 26.2cm x 10.7cm) 5.6lbs (2.54kg) CE |     |



F

| Analog Dark Woodgrain Wall <i>Cloth Grille</i> |  | VPU |
|--|--|-----|
| F  | <b>Angled Wall</b>   |     |
|  | <b>One-Way</b> ..... V-1023C   | -1  |
|  | 9.6"H x 11.5"W x 4.2"D (24.4cm x 29.2cm x 10.7cm) 4.1lbs (1.86kg)    |     |
|  | <b>Talkback</b> ..... V-1063A  | 0   |
|  | 10.6"H x 9.7"W x 5.2"D (26.92cm x 24.64cm x 13.21cm) 4.0lbs (1.81kg) |     |



**Accessory:** *Optional*

- Works with All Wall Speakers on page 16 (Except Bi-Directional Corridor Wall Speakers)



**Wire Cage** (2 Pack) ..... V-WGWALL-2  
12"H x 16.5"W x 5.5"D (30.5cm x 41.9cm x 14.0cm) 2.35lbs (1.1kg)



## A Vandal-Resistant Wall Speakers

- Steel-Mesh Security-Baffle Prevents Objects from Penetrating the Speaker
- Tamper-Resistant Faceplate Screws Resist Removal
- Easy Mounting to Any Solid Surface
- Heavy-Gauge Steel Construction
- 8" Self-Amplified Speaker with Adjustable Volume
- Gray Powder-Coat Finish, Custom Colors Available on Request

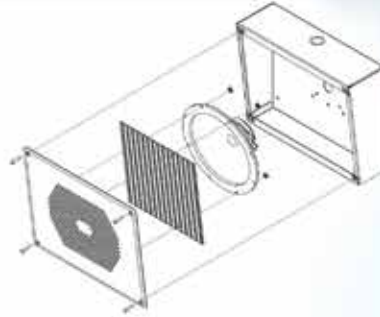

| Analog Vandal-Resistant Wall Speakers                                   |        | VPU |
|---|--------|-----|
| Colors: Gray, (Paintable), Custom Colors -CC                            |        |     |
| <b>A One-Way</b> .....  | V-9852 | - 1 |
| <b>Talkback</b> .....   | V-9871 | 0   |
| 10.00"H x 12.25"W x 4.00"D (25.4cm x 31.12cm x 10.16cm) 8.35lbs (3.8kg) |        |     |

## B, C, D Vandal-Resistant FlexHorns™

- Steel Mesh Baffle Prevents Objects from Penetrating the Speaker
- Tamper-Resistant Faceplate (Screws Resist Removal)
- Mounting Holes for Single-Gang, Double-Gang or Octagon Outlet Box or Attachment to Any Solid Surface
- Heavy Gauge Steel Construction with Gray Powder Coat Finish, Custom Colors Available on Request

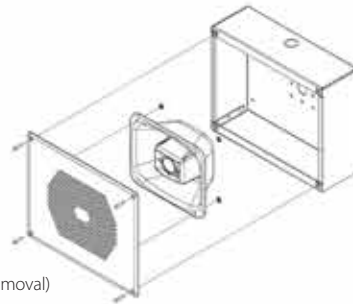

**B Surface Mount Unit**



**C Dual FlexHorn Surface Mount Unit Great for Hallways!**



**D Angled Surface Mount Unit**

| Analog Vandal-Resistant FlexHorns™                                      |        | IP SoundPoints® |
|---|--------|-----------------|
| <b>B Surface Mount Unit</b>   | VPU    |                 |
| Colors: Gray, (Paintable), Custom Colors -CC                            |        |                 |
| <b>One-Way</b> .....  | V-9880 | - 3             |
| <b>Talkback</b> .....   | V-9890 | 0               |
| <b>IP One-Way or Talkback Programmable</b> .....                        |        | VIP-580A        |
| <b>IP One-Way, InformaCast®</b> .....                                   |        | VIP-580A-IC     |
| 10.00"H x 12.25"W x 4.00"D (25.4cm x 31.12cm x 10.16cm) 8.35lbs (3.8kg) |        |                 |
| <b>C Dual FlexHorn Surface Mount Unit</b>                               |        |                 |
| Colors: Gray, (Paintable), Custom Colors -CC                            |        |                 |
| <b>One-Way</b> .....  | V-9885 | - 6             |
| 10.00"H x 12.25"W x 7.38"D (25.4cm x 31.12cm x 18.75cm) 12.1lbs (5.5kg) |        |                 |
| <b>D Angled Surface Mount Unit</b>                                      |        |                 |
| Colors: Gray, (Paintable), Custom Colors -CC                            |        |                 |
| <b>IP One-Way or Talkback Programmable</b> .....                        |        | VIP-581A        |
| <b>IP One-Way, InformaCast®</b> .....                                   |        | VIP-581A-IC     |
| 10"H x 12.12"W x 4.00"D (25.4cm x 30.99cm x 10.16cm) 7.1lbs (3.22kg)    |        |                 |

# Horns

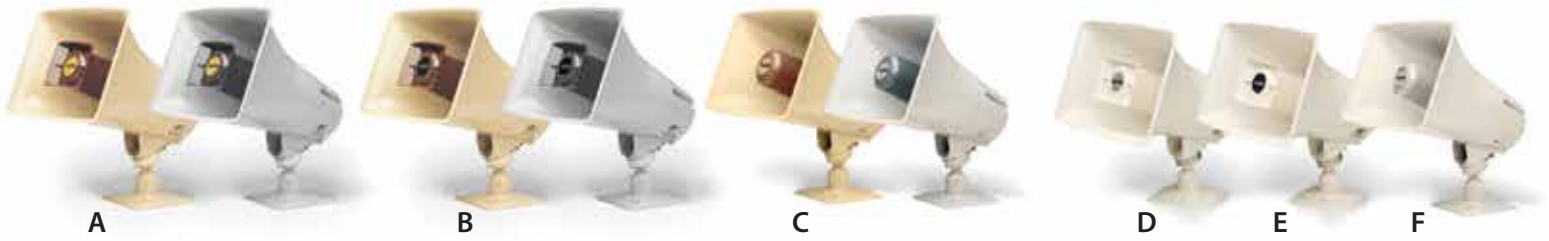

## A High-Efficiency Horns

**B** For Industrial, Manufacturing, Warehouse Areas  
**C**

- Very High-Efficiency Ensures Penetration w/Lower Energy Consumption
- Features Easy Omni-Lock I-Beam Clamp Mounting System
- Suitable for Indoor or Outdoor Installation
- Weather-Resistant

## G High-Noise

*Environments When You Really Need Power*

- Higher Noise Environment
- Stainless Steel Hardware
- Weather-Resistant

*Requires -48 Vdc, 1A or VP-2148D Power Supply for 2 Horns*



## H Paging In Two Directions

*Bi-Directional Horn is Ideal for Long, Narrow Aisles*

- Ideal for: Warehouses, Parking Lots, Complexes, Stadiums
- Stainless Steel Hardware
- Suitable for Indoor or Outdoor Installation
- Weather-Resistant



## I Explosive Atmospheres

*Safety-Assured for Explosive Atmospheres*

- Solid Metal Housing
- Includes V-1092 Volume Control
- UL Listed For Use In: Class I, Groups C&D Gas Atmospheres



### Accessory: Wire Cage

for Horns (2 Pack) ... V-WGHORN-2  
for All Horns (Except Bi-Directional & Explosion-Proof Horns)  
19"H x 20.5"W x 17.5"D  
(48.26cm x 52.07cm x 44.45cm)  
7.05lbs (3.20kg)



## D Marine Horns

**E** Resists Deteriorating Effects of Salt, Sun, High Humidity  
**F**

- Equipped w/O-Ring Seals
- Features Easy Omni-Lock I-Beam Clamp Mounting System
- Suitable for Indoor or Outdoor Installation

| Analog Horns   |     | IP SoundPoints®        |           |
|--|-----|------------------------|-----------|
| <b>High-Efficiency Horn</b>  |     | VPU                    |           |
| <b>A 5-Watt</b> 3.6lbs (1.63kg)  |     |                        |           |
| One-Way Beige.....V-1030C  | -5  | .....VIP-130AL-BGE*    |           |
| IP One-Way InformaCast® Beige.....   |     | .....VIP-130AL-BGE-IC* |           |
| One-Way Gray.....V-1030C-GY  | -5  | .....VIP-130AL-GY*     |           |
| IP One-Way InformaCast® Gray.....  |     | .....VIP-130AL-GY-IC*  |           |
| <b>B 15-Watt</b> 3.7lbs (1.68kg)   |     |                        |           |
| One-Way Beige.....V-1036C  | -15 |                        |           |
| One-Way Gray.....V-1036C-GY  | -15 |                        |           |
| <b>C Talkback</b> 3.4lbs (1.5kg)   |     |                        |           |
| Talkback Beige.....V-1048C   | 0   | .....VIP-148AL-BGE*    |           |
| IP Talkback InformaCast® Beige.....  |     | .....VIP-148AL-BGE-IC* |           |
| Talkback Gray.....V-1048C-GY   | 0   | .....VIP-148AL-GY*     |           |
| IP Talkback InformaCast® Gray.....   |     | .....VIP-148AL-GY-IC*  |           |
| 7.38"H x 10.0"W x 10.4"D (18.75cm x 25.4cm x 26.42cm)<br>IP Horns: 5.8lbs (2.63kg) |     |                        |           |
| <b>Marine Horn</b>   |     |                        |           |
| <b>D 5-Watt</b> 3.7lbs (1.68kg)  |     |                        |           |
| One-Way White.....V-1030M  | -5  | .....VIP-130AL-M*      |           |
| IP One-Way InformaCast® White.....   |     | .....VIP-130AL-M-IC*   |           |
| <b>E 15-Watt</b> 3.7lbs (1.68kg)   |     |                        |           |
| One-Way White.....V-1036M  | -15 |                        |           |
| <b>F Talkback</b> 3.5lbs (1.59kg)  |     |                        |           |
| Talkback White.....V-1048M   | 0   | .....VIP-148AL-M*      |           |
| IP Talkback InformaCast® White.....  |     | .....VIP-148AL-M-IC*   |           |
| 7.38"H x 10.0"W x 10.4"D (18.75cm x 25.4cm x 26.42cm)<br>IP Horns: 5.8lbs (2.63kg) |     |                        |           |
| <b>G 30-Watt</b>   |     |                        |           |
| One-Way Beige.....V-1038   |     |                        | Use 48VDC |
| 7.68"H x 12.25"W x 11.62"D (19.53cm x 31.12cm x 29.53cm)<br>4.1lbs (1.86kg)        |     |                        |           |
| <b>H Bi-Directional Horn</b>   |     |                        |           |
| One-Way Beige.....V-1050C  | -6  |                        |           |
| 9.60"H x 8.20"W x 9.30"D (24.38cm x 20.83cm x 23.62cm)<br>6.3lbs (2.86kg)          |     |                        |           |
| <b>I Explosion-Proof Horn</b>  |     |                        |           |
| One-Way Gray.....V-1039A   | -20 |                        |           |
| 6"H x 14"W x 17.5"D (15.24cm x 35.56cm x 44.45cm)<br>19lbs 8.62kg                  |     |                        |           |
| Talkback Gray.....V-1069A  | 0   |                        |           |
| 8"H x 14.6"W x 17"D (20.32cm x 37.08cm x 43.18cm)<br>19lbs (8.62kg)                |     |                        |           |

\*Long Line Extender

## Stealth Horns

### A Stealth Horn

- Houses a Valcom One-Way FlexHorn™
- Surface Mount, Easy to Install
- 20-Gauge Aluminum Powder Coat Paint Cover



**A**

### B Stealth Corridor Speaker — Surface Mount

- Corridor Houses a 6-Inch Speaker

**B**

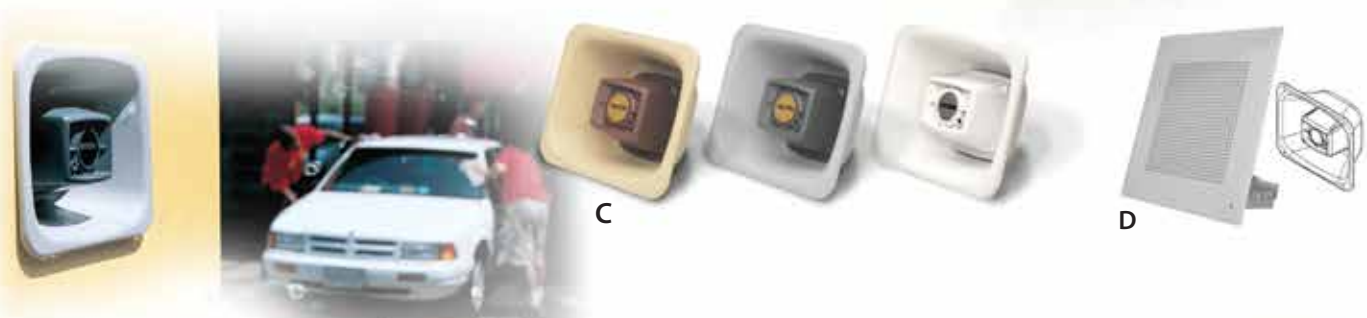
| Analog Stealth Horns |   | IP SoundPoints® |               |
|----------------------|---|-----------------|---------------|
| <b>A</b>             | Colors: Architectural Bronze -BR, White -W, Custom Colors -CC     | VPU             |               |
|                      | <b>One-Way</b> Indoor/Outdoor 7.6lbs (3.45kg).....V-9830          | ③               | VIP-9831A     |
|                      | <b>IP One-Way</b> Indoor 12.1lbs (5.5kg).....                     |                 |               |
|                      | 10.00"H x 12.25"W x 7.38"D (25.4cm x 31.12cm x 18.75cm)           |                 |               |
| <b>B</b>             | <b>Stealth Speaker Corridor Surface Mount</b>                     |                 |               |
|                      | Colors: Architectural Bronze -BR, White -W, Custom Colors -CC     |                 |               |
|                      | <b>One-Way</b> Indoor .....V-9815                                 | ③               | VIP-9815A     |
|                      | <b>IP One-Way or Talkback Programmable</b> Indoor.....            |                 | VIP-9815A-IC  |
|                      | <b>IP One-Way, InformaCast®</b> Indoor.....                       |                 | VIP-9815AL-IC |
|                      | 9.3"H x 15.0"W x 5.0"D (23.6cm x 38.1cm x 12.7cm) 5.5lbs (2.05kg) |                 |               |

**C**
**D**

## FlexHorn™ — The Rugged Speaker

**A Compact Design Perfect For:**

- Low Ceilings Such as Light Manufacturing or Multi-Floor Warehouses
- Low to Moderate Noise Environments
- Perfect Solution for Gymnasiums, Prisons, Subways, Train Stations, Schools, Drive-Thrus, & Parking Garages
- Water-Proof for Environments Requiring Direct Spray Down Such as Car Washes, Food Processing Plants, & Operating Rooms

### Mounting Options:

**Recessed FlexHorn**  
The V-1080 and V-1090 Can Be Mounted in Wall.

### Adjustable Mounting Bracket

• Included with FlexHorn  
Mount on Wall, Ceiling, or Beam..... V-9804  
5.8"H x 2.75"W x 2.05"D  
(14.73cm x 6.99cm x 5.21cm) 0.7lbs (0.32kg)



### Accessories:

**Wire Cage (2 Pack)**..... V-WGFLEX-2  
13.00"H x 14.88"W x 10.51"D  
(33.02cm x 37.80cm x 26.70cm) 3.2lbs (1.50kg)



### To Make FlexHorns Vandal-Resistant:

Stainless Steel  
**Enclosure & Faceplate** ..... V-9805  
8.50"H x 11.00"W x 4.00"D  
(21.59cm x 27.94cm x 10.16cm) 7.5lbs (3.4kg)



Stainless Steel  
**Faceplate**..... V-9806  
8.50"H x 11.00"W x .125"D  
(21.59cm x 27.94cm x .32cm) 2.0 lbs (0.91 kg)



Heavy Gauge Steel, Gray, Paintable  
**Enclosure & Faceplate** ..... V-9809  
10.00"H x 12.25"W x 4.00"D  
(25.4cm x 31.12cm x 10.16cm) 7.0lbs (3.2kg)



| Analog FlexHorn™ |   | IP SoundPoints® |               |
|------------------|---|-----------------|---------------|
| <b>C</b>         | Colors: Beige - BGE, Gray -GY, White -W                               | VPU             |               |
|                  | <b>One-Way</b> 2.1lbs (0.95kg) ..... V-1080                           | ③               | VIP-480AL*    |
|                  | <b>IP One-Way InformaCast®</b> .....                                  |                 | VIP-480AL-IC* |
|                  | <b>Talkback</b> 2.0lbs (0.91kg) ..... V-1090                          | ①               | VIP-490AL*    |
|                  | <b>IP Talkback InformaCast®</b> .....                                 |                 | VIP-490AL-IC* |
|                  | 6.80"H x 8.30"W x 3.30"D (17.27cm x 21.08cm x 8.38cm)                 |                 |               |
| <b>D</b>         | <b>IP FlexHorn Square Surface Mount Faceplate</b>                     |                 |               |
|                  | White, (Paintable), Custom Colors -CC                                 |                 |               |
|                  | <b>IP One-Way or Talkback Programmable</b> .....                      |                 | VIP-9880A     |
|                  | <b>IP One-Way, InformaCast®</b> .....                                 |                 | VIP-9880A-IC  |
|                  | 11.5"H x 11.5"W x 4.00"D (29.21cm x 29.21cm x 10.2cm) 4.0lbs (1.81kg) |                 |               |
|                  | <b>Backbox: Recessed Mount</b> ..... VB-R17-D                         |                 |               |
|                  | 9.63"H x 9.63"W x 5.94"D (24.46cm x 24.46cm x 15.088cm)               |                 |               |

\* Long Line Extender

# Power Supplies

## Meets Energy Star Rating!

### Power Supplies with Long Life Capacity!

- Smaller Footprint
- 100 – 240V
- Wall, Rack/Rail Mount,
- Less Energy/Less Heat
- Barrel to Wire Connection
- Mounting Bracket Included



| Analog  |   | Digital     | VPU |
|---|---|-------------|-----|
| <b>A</b>  | <b>300mA/24V</b> .....                  | VP-324D     | +6  |
| 2.84"H x 1.73"W x 1.08"D (7.21cm x 4.40cm x 2.74cm) 0.20lbs (0.09kg)  |   |             |     |
| <b>B</b>  | <b>600mA/24V</b> .....                  | VP-624D     | +12 |
| 1.42"H x 1.50"W x 3.58"L (3.6cm x 3.8cm x 9.1cm) 0.36lbs (0.17kg)   |   |             |     |
| <b>C</b>  | <b>1 Amp/24V</b> .....                  | VP-1124D    | +20 |
|   | <b>1 Amp/24V UK Version</b> .....       | VP-1124D-UK | +20 |
| 1.25"H x 1.80"W x 3.88"L (3.2cm x 4.6cm x 9.9cm) 0.40lbs (0.2kg)  |   |             |     |
| <b>D</b>  | <b>2 Amp/24V</b> .....                  | VP-2124D    | +40 |
|   | <b>2 Amp/24V European Version</b> ..... | VP-2124D-EC | +40 |
|   | <b>2 Amp/24V UK Version</b> .....       | VP-2124D-UK | +40 |
| 1.45"L x 2.35"W x 4.75"L (3.7cm x 2.35cm x 12.1cm) 0.60lbs (0.3kg)  |   |             |     |
| <b>E</b>  | <b>2 Amp/-48V</b> .....                 | VP-2148D    | N/A |
| For the V-1038, 30-Watt Horn, page 18<br>1.5"H x 2.60"W x 6.61"L (3.9cm x 6.6cm x 16.8cm) 1.10lbs (0.5kg)   |   |             |     |
| <b>F</b>  | <b>4 Amp/24V</b> .....                  | VP-4124D    | +80 |
|   | <b>4 Amp/24V European Version</b> ..... | VP-4124D-EC | +80 |
| 1.4"H x 2.65"W x 6.65"L (3.6cm x 6.7cm x 16.9cm) 1.15lbs (0.52kg)   |   |             |     |
| 230Vdc Power Supplies:<br>-EC European Power Supply (Plug Included)<br>-UK United Kingdom Power Supply (Plug Included)<br>-E 230Vdc Power Supply (Without Plug) |   |             |     |

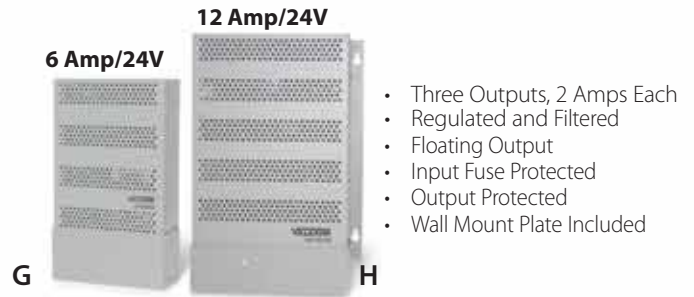

- Three Outputs, 2 Amps Each
- Regulated and Filtered
- Floating Output
- Input Fuse Protected
- Output Protected
- Wall Mount Plate Included

| Analog  |  | Switching Digital | VPU  |
|---|--|-------------------|------|
| <b>G</b>  | <b>6 Amp/24V</b> .....   | VP-6124           | +120 |
|   | <b>6 Amp/230 VAC / .86A; 165W European Version</b> .....         | VP-6124-E         | +120 |
| 10.30"H x 5.92"W x 2.50"D (26.16cm x 15.04cm x 6.35cm) 5.0lbs (2.27kg)  |  |                   |      |
|   | <b>Power Supply Shelf Holds Two VP-6124 Power Supplies</b> ..... | VP-9202           | N/A  |
| • Occupies Two RU's (Rack Spaces or Units) in a Standard 19" Rack<br>12.5"H x 5"W x 0.75"D (31.75cm x 12.7cm x 1.9cm) 5.4lbs (2.43kg) |  |                   |      |
| <b>H</b>  | <b>12 Amp/24V</b> .....  | VP-12124          | +240 |
| 12.10"H x 8.70"W x 3.90"D (30.70cm x 22.10cm x 9.90cm) 7.7lbs (3.5kg)   |  |                   |      |

| Analog  |                                   | Special Purpose          | VPU |
|---|-----------------------------------|--------------------------|-----|
|   |                                   | Power for V-9970, Page 8 |     |
|   | • Receptacle Mount                |                          |     |
|   | <b>400mA/12V Unfiltered</b> ..... | VP-412A                  | N/A |
| 2.60"H x 2.00"W x 2.30"D (6.60cm x 5.08cm x 5.84cm) 0.5lbs (0.23kg) |                                   |                          |     |

| IP Local Power Option for VoIP Products                              |                              | VPU      |
|--|------------------------------|----------|
|  | • Receptacle Mount           |          |
|  | <b>IP 24VDC, 300mA</b> ..... | VIP-324D |
| 2.84"H x 1.73"W x 1.08"D (7.21cm x 4.40cm x 2.74cm) 0.20lbs (0.09kg) |                              |          |

## Step 3 Select a Power Supply

Built-in power is often included in the page control, so an additional power supply may not be needed. The amount of power required for a paging system is based on the quantity and type of page control and speakers/horns selected.

### Easy Selection Considerations:

Valcom Products are Assigned Valcom Power Units (VPU)

Products Either **Provide + #** or **Consume - #** Power

### Valcom Power Units Make It Easy!

|                          |   |
|--------------------------|---|
| <b>Simply Total All:</b> | <b>Example:</b>                         |
| a. Page Control VPU's    | Page Control 1 x +30 = +30 VPU Provided |
| b. Speaker/Horn VPU's    | Speakers 15 x -1 = -15 VPU Consumed     |
| c. Subtract b. from a.   | = +15 VPU's LEFT OVER                   |
|                          | NO Power Supply Needed!                 |

- Products that Neither Consume NOR Provide Power are a 0
- Note: One Valcom Power Unit = 50mA, -24 Vdc
- VPU Listings are on the Product Pages & Index
- Have VPU's Left Over - You Can Add More Speakers!
- Need More - Simply Select a Power Supply with Enough VPU's to Make up the Difference!

## Back-Up Power

### Battery Back-Up Power

- Contains Long Life Maintenance-Free Gel Cell Batteries
- Fuse-Protected AC Input, Current Limiting on Output
- Connects Directly to Battery Back-Up Molex Connector on Compatible Equipment
- 12 and 24 Volts DC, Fused at 3 Amps



### Battery Back-Up Charger

- Provides a Battery Source to Permit System Operation in the Event of an AC Power Failure
- Specifications: 14AH @ -24Vd
- For Use with VP-6124 Power Supply/VBB-1424



### Battery Box with Batteries (Not Pictured)

- Complete your UPS System with Battery Support
- For Use with VP-6124 / VP-6124-UPS

| Analog   |   | Battery Back-Up Power | VPU |
|--|---|-----------------------|-----|
| <b>I</b>   | <b>Battery Back-Up Power</b> .....      | VPB-260               | N/A |
| 9.25"H x 7.5"W x 5.25"D (23.5cm x 19.05cm x 13.3cm) 16lbs (7.2kg)        |   |                       |     |
| <b>J</b>   | <b>Battery Back-Up Charger</b> .....    | VP-6124-UPS           | 0   |
| 10.30"H x 3.50"W x 2.25"D (26.16cm x 8.89cm x 5.72cm) 2.90lbs (1.32kg)   |   |                       |     |
| No Pic.  | <b>Battery Box with Batteries</b> ..... | VBB-1424              | 0   |
| 5.52"H x 8.03"W x 10.82"D (14.02cm x 20.40cm x 27.48cm) 17.5lbs (7.88kg) |   |                       |     |

## SIP Door Intercom

**Exterior IP intercom and door phone with paging capabilities. Using a standard electrical junction box enclosure for flush mount or outdoor surface junction box... This IP intercom can be easily installed in a variety of environments such as assisted living facilities, correctional facilities, business offices, school classrooms and more. Communicate with or without a SIP PBX.**

- SIP Compliant and Valcom Gateway Accessible
- Peer-to-Peer Capable
- PoE 802.3af Enabled (Power-over-Ethernet)
- Optional: Hi Security Smart Relay for Door Latches — VM-SRLY
- Fully Network Configurable
- Uses a Standard Electrical Junction Box Enclosure
- High Loudspeaker Levels for Use in Moderate to High Noise Areas
- Paging Speaker Feature
- Mic and Speaker Volume Control
- Stainless Steel
- LED Call Status
- Multicast
- Enhanced Tamper-Resistance
- Optional: FXS or FXO Access

**Designed, manufactured and supported in the USA.**



**A** VIP-176

## SIP Intercom with Long Line Extender (LLE)

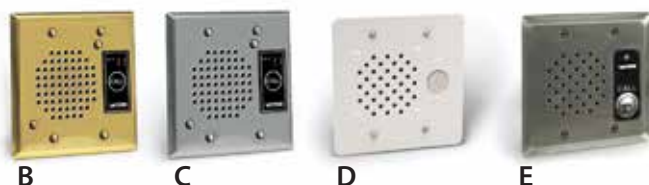
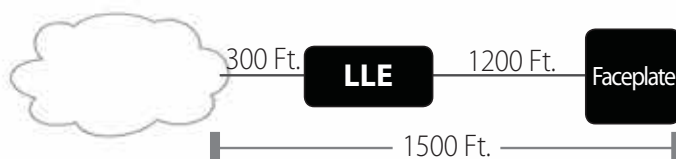

### Long Line Situations Such as Elevators, etc.

- Use with Cisco, Nortel, Avaya, and Most Modern IP Telephone Systems
- Automatic Talkback VOX Operation (No Push to Talk Button Needed)
- Companion to IP CCTV Cameras
- SIP or Multicast Communications
- All Call 1000's of Units with Valcom Gateway
- LED Status Indicator
- Weather and Tamper-Resistant
- Compatible with Secure Networks
- Supervision with Alert Functions
- DHCP Addressable
- High Survivability – No Server Needed
- Built-In Access Control Relay

### Flush Mount Vandal-Resistant

- Weather-Resistant
- Talkback Speaker
- Call Button
- Mounts in Standard Double Gang Electric Box
- 11 Gauge Steel, White Paintable Faceplate
- 16 Gauge Steel, Stainless Steel Faceplate - IP Version



**Accessory:**  
**Doorbox Weather Guard**  
 Black ..... V-9910-BK  
 Yellow ..... V-9910-YEL

| Doorplate Speakers |  | Analogue | SIP              |
|--------------------|--|----------|------------------|
| <b>A</b>           | <b>SIP Doorplate Vandal-Resistant IP Talkback Stainless Steel</b> 0.75lbs (0.34kg) ..... 4.75"H x 4.75"W x 2.25"D (12.06cm x 12.06cm x 5.71cm) | VPU      | VIP-176          |
| <b>B</b>           | <b>Brass Talkback</b> ..... V-1072A-BRASS  | 0        | VIP-172AL-BRASS* |
|                    | <b>Talkback w/LED</b> ..... V-1072B-BRASS  | 0        |                  |
| <b>C</b>           | <b>Stainless Steel Talkback</b> ..... V-1072A-ST   | 0        | VIP-172AL-ST*    |
|                    | <b>Talkback w/LED</b> ..... V-1072B-ST   | 0        |                  |
| <b>D</b>           | <b>Vandal-Resistant Talkback White</b> 1.5lbs (0.68kg) ..... V-1073  | 0        | VIP-172AL-VRSS*  |
| <b>E</b>           | <b>Talkback w/LED Stainless Steel</b> 1.68lbs (0.76kg) ..... 4.5"H x 4.5"W x 1.75"D (11.43cm x 11.43cm x 4.45cm)                               | 0        |                  |

\* Long Line Extender

## Analog Door Answering/Unlock Devices

### Answer & Door Unlock Capability



**F**

#### Single Door

- Door Unlock Contact Closure (Strikeplate Required)
- Alarm Functions
- Transmit and Receive Volume Controls
- Background Music Input with Volume Control
- Built-In Ring Generator with On/Off Switch
- 3 Distinctive Ring Patterns
- Programmable Options Include:
  - Door Unlock Codes
  - # of Ring Cycles Before Door Request is Terminated
  - Time the Door Remains Unlocked
- Requires -24 Vdc, 600mA (Filtered)



**G**

- Four Door** – All the Functions of the Single Door Plus:
  - Places Simultaneous Calls In Queue

### Answering Control (Does Not Provide Door Unlock Capability)

#### Single Door

- Ring Generator
- Built-In Talkback Amplifier
- Transmit and Receive Volume Control
- Provides Two-Way Communication
- Power Supply Included (VP-324D)



**H**

| Door Answering Devices |  | Analogue |
|------------------------|--|----------|
| <b>F</b>               | Single Door ..... V-2901A  | VPU -12  |
|                        | 8.60"H x 11.00"W x 2.30"D (21.84cm x 27.94cm x 5.84cm) 3.0lbs (1.36kg) |          |
| <b>G</b>               | Four Door ..... V-2904   | -12      |
|                        | 8.60"H x 11.00"W x 2.30"D (21.84cm x 27.94cm x 5.84cm) 3.1lbs (1.41kg) |          |
| <b>H</b>               | Single Door Answering Control ..... V-2900                             | 0        |
|                        | 8.25"H x 4.5"W x 2.35"D (20.96cm x 11.43cm x 5.97cm) 3.1lbs (1.41kg)   |          |

## Privacy - Noise Generator



A

### Spot SoundMasking Speaker™ w/Noise Generator

Reduces Possibility of Conversations Being Overheard by Hallway Traffic — Ideal for Clergy, Human Resources, Counselors, Financial Offices & Attorneys

- Constant 'White Noise' (Hissing Sound)
- Built-In Electronics and Power Supply Included
- Easy Installation - Replaces A Hallway Ceiling Tile
- Self-Contained With Built-In Masking Source and Amplifier
- T-Bar Included

| Analog Spot SoundMasking                     |   | VPU |
|--|---|-----|
| Colors: White (Paintable), Custom Colors -CC |   |     |
| A  | 2' x 2' Lay-In Spot SoundMasking Speaker.....V-9422<br>23.75"L x 23.75"W x 3.75"D (60.33cm x 60.33cm x 9.53cm) 5.5lbs (2.48kg) ASTM E84, CE | NA  |

## Call Buttons



### Call-In Switches

Provides Remote Call-In Capability

- Fits a Single Gang Box

| Analog Call-In Switches       |  |  | VPU |
|-------------------------------|--|--|-----|
| <b>With Volume Control</b>    |  |  |     |
| D                             | Call-In Switch <i>Stainless Steel</i> .....V-2971<br>4.5"H x 2.75"W x 1.0"D (11.43cm x 6.99cm x 2.54cm) 0.2lbs (0.09kg)                        |  | 0   |
| E                             | Call-In Switch <i>White</i> .....V-2991-W<br>4.5"H x 2.75"W x 0.75"D (11.43cm x 6.99cm x 1.91cm) 0.2lbs (0.09kg)                               |  | 0   |
| F                             | Emergency/Normal Call Switch <i>Stainless Steel</i> .....V-2970<br>4.5"H x 2.75"W x 1.0"D (11.43cm x 6.99cm x 2.54cm) 0.2lbs (0.09kg)          |  | 0   |
| G                             | Emergency/Normal Call Switch <i>White</i> .....V-2995-W<br>4.5"H x 2.75"W x 1.0"D (11.43cm x 6.99cm x 2.54cm) 0.2lbs (0.09kg)                  |  | 0   |
| H                             | Call-In Switch w/Privacy Switch <i>White</i> .....V-9320<br>4.5"H x 2.75"W x 1.0"D (11.43cm x 6.99cm x 2.54cm) 0.2lbs (0.09kg)                 |  |     |
| <b>Without Volume Control</b> |  |  |     |
| I                             | Rocker Push Button Call-In Switch <i>Stainless Steel</i> V-2972PK<br>4.5"H x 2.75"W x 1.5"D (11.43cm x 6.99cm x 3.91cm) 6 Pack: 1.1lbs (0.5kg) |  | 0   |
| J                             | Emergency Call-In Switch <i>Vandal-Resistant, Red</i> .....V-2976<br>4.50"H x 2.75"W x 1.00"D (11.43cm x 6.98cm x 2.54cm) 0.25lbs (0.12kg)     |  | 0   |

## Measuring Sound

### Volume Control Sensors

When Noise Levels Change, So Do Your Speakers – Automatically

- Constantly Monitors the Area & Automatically Adjusts the Volume of the Paging Speakers
- Use One Per Zone and/or One Per Noise Area
- Specifications: Output Impedance: 8 ohm
- Power Requirements: -24Vdc, 100mA



B

### Remote Microphone (Must be used w/V-9933A)

Measure Your Environments Sound Level

- Self-Contained Microphone & Pre-Amp
- No Power Supply Required
- Up to 4 Units May Be Paralleled on One V-9933A



C

| Analog Volume Control Sensors |  | VPU |
|-------------------------------|--|-----|
| B                             | Noise Sensing Volume Control .....V-9933A<br>7.30"H x 4.50"W x 2.00"D (18.54cm x 11.43cm x 5.08cm) 0.9lbs (0.41kg) | 2   |
| C                             | Remote Microphone .....V-9934<br>1.50"H x 2.90"W x 0.81"D (3.81cm x 7.37cm x 2.06cm) 0.06lbs (0.03kg)              | NA  |

## Controlling Sound



### Speaker Volume Controls

- Controls Volume of up to 150 One-Way Speakers
- Stainless Steel or White

| Analog Speaker Volume Controls |  |  | VPU |
|--------------------------------|--|--|-----|
| K                              | Speaker Volume Control <i>Stainless Steel</i> .....V-1092<br>4.5"H x 2.75"W x 2.0"D (11.43cm x 6.99cm x 5.08cm) 0.8lbs (0.36kg)                            |  | 0   |
| L                              | Speaker Volume Control without Single Gang Box <i>Stainless Steel</i> .....V-1092B<br>4.5"H x 2.75"W x 1.0"D (11.43cm x 6.99cm x 2.54cm) 0.2lbs (0.09kg)   |  | 0   |
| M                              | Speaker Volume Control <i>White</i> .....V-2992-W<br>4.5"H x 2.75"W x 0.63"D (11.43cm x 6.99cm x 1.59cm) 0.2lbs (0.09kg)                                   |  | 0   |
| N                              | Speaker Volume Control-Slide Switch <i>Stainless Steel</i> .....V-1097<br>4.5"H x 2.75"W x 2.0"D (11.43cm x 6.99cm x 5.08cm) 0.8lbs (0.36kg) ADA Compliant |  | 0   |

## Microphones

### Microphone Panel w/ Stored Messages



- Record Up to 8 Stored Messages—Microphone for Live Announcements**
- Stores & Plays Up to 8 Recorded Messages over Paging System
  - Provides 8 Minutes of High Quality Digital Recording
  - Eight Front Panel Buttons – Each with LED Message Cancel Button
  - Push-to-Talk Microphone for Live Announcements
  - Power "ON" & Visual System Fault Indicator
  - Easy Programming to Upload/Download Voice Messages
  - Optional Audio Interface Available (V-1096)

| Analog Microphone Panel |  | VPU |
|-------------------------|--|-----|
| <b>A</b>                | Stored Message/Mic Page Panel ..... V-9908<br>4.25"H x 5"W x 2"D (10.8cm x 12.7cm x 5.08cm) 4.0lbs (1.5kg) | -5  |
| No Pic.                 | Audio Interface ..... V-1096<br>1.75"H x 3.75"W x 1.25"D (4.45cm x 9.53cm x 3.2cm) 0.5lbs (0.23kg)         | 0   |

## Microphones

### Desk Paging Microphone

- Omni-Directional Pickup Pattern
- Push-To-Talk Switch & Locking Bar
- Lift-to-Talk Switch w/Bypass Slide Switch Provided



### Dynamic Noise Canceling Microphone

- Handheld w/Press-To-Talk Lever
- Heavy Duty Coil Cord Extends to 6'



### Gooseneck Microphone

- Omni-Directional Pickup Pattern
- Push-To-Talk Switch



### Microphone Adapter

- Provides Contact Closure
- Specifications: In/Out Impedance: 50Kohm Unbalanced; 600ohm Balanced; Power Requirements: -24Vdc Filtered 40mA

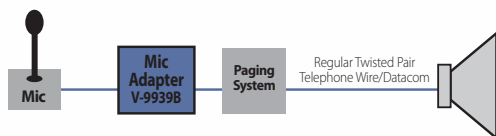

| Analog Microphones |  | VPU |
|--------------------|--|-----|
| <b>B</b>           | Desk Paging Microphone ..... V-400<br>9.4"H x 4.0"W x 6.0"D (23.88cm x 10.16cm x 15.24cm) 1.4lbs (0.64kg)                          | 0   |
| <b>C</b>           | Dynamic Noise Canceling Microphone ..... V-420<br>3.94"H x 2.97"W x 2.63"D (10.00cm x 7.54cm x 6.68cm) 0.63lbs (0.29kg)            | 0   |
| <b>D</b>           | Gooseneck Microphone ..... V-450<br>Microphone: 1.75"Dia x 4.625"L (4.44cm x 11.75cm),<br>Gooseneck 19"L (48.26cm) 1.3lbs (0.59kg) | 0   |
| <b>E</b>           | Microphone Adapter ..... V-9939C<br>8.25"H x 4.5"W x 2.35"D (20.95cm x 11.43cm x 5.97cm) 0.7lbs (0.32kg)                           | -1  |

## Paging Expansion

### Input Line Matching Transformer



Connects System to Most Public Address Amps for Phone Paging

- Functions as Output-matching Transformer to Feed Program Material Over a 600-ohm Telephone Line for "Music-on-Hold"
- Compatible w/Any 25V Output Connection Amplifier
- Hi-Z, 10k-ohm Primary Impedance
- Lo-Z, 600-ohm Secondary Impedance, Balanced w/Center Tap
- Matches High-to-Low Impedance or Low-to-High Impedance
- Adapts Line Level Signals to Microphone Inputs

### Audio Isolation Transformer



- Magnetically Coupling Line Level Audio
- Isolating Ground References From One Audio Circuit to Another

## 25/70/100 Volt Paging Expansion

Expand 25/70/100 Volt Systems w/o Straining the Existing Amplifier

- Connects to Amplifier Output or Anywhere on 25/70/100 Volt Line
- No Costly Amplifiers or Heavy Gauge Cable Required
- Specifications: Output Impedance: 8 ohm
- Single Gang Box



| Analog Paging Expansion |   | VPU |
|-------------------------|---|-----|
| <b>F</b>                | Input Line Matching Transformer ..... VMT-1<br>1.75"H x 3.75"W x 1.25"D (4.45cm x 9.53cm x 3.18cm) 0.5lbs (0.23kg)          | N/A |
| <b>G</b>                | Audio Isolation Transformer ..... VMT-2<br>1.75"H x 3.75"W x 1.25"D (4.45cm x 9.53cm x 3.18cm) 0.5lbs (0.23kg)              | N/A |
| <b>H</b>                | 70 Volt Expander <i>Stainless Steel</i> ..... V-1095<br>4.5"H x 2.75"W x 2.88"D (11.43cm x 6.99cm x 7.32cm) 0.9lbs (0.41kg) | 0   |

## Page Expansion

With These Little Boxes You Can Add Speakers On & On & On...

- Pre-Amplifies Low Level Audio to Remote Sites
- Virtually Unlimited Expansion (150 One-Way Speakers Per Box)
- Master Volume Control for Entire System/Groups of Remote Speakers
- Isolates Page Port from Speaker Lines
- Specifications: Output Impedance: 8 ohm Power Requirements: -24Vdc, 45mA
- Single Gang Box



Unlimited Expansion Is A Breeze w/Valcom Amplified Speakers

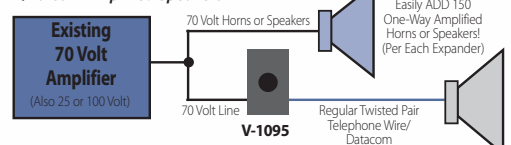

| Analog Paging Expansion |  | VPU |
|-------------------------|--|-----|
| <b>I</b>                | Page Port PreAmp/Expander <i>Stainless Steel</i> ..... V-1094A<br>4.5"H x 2.75"W x 2.0"D (11.43cm x 6.99cm x 5.08cm) 0.8lbs (0.38kg) | -1  |
| <b>J</b>                | Page Port PreAmp/Expander w/o Single Gang Box SS ... V-1094B<br>4.5"H x 2.75"W x 0.75"D (11.43cm x 6.99cm x 1.91cm) 0.2lbs (0.09kg)  | -1  |
| <b>K</b>                | Page Port PreAmp/Expander <i>White</i> ..... V-2994-W<br>4.5"H x 2.75"W x 1.70"D (11.43cm x 6.99cm x 4.32cm) 0.2lbs (0.09kg)         | -1  |

## Managing Sound

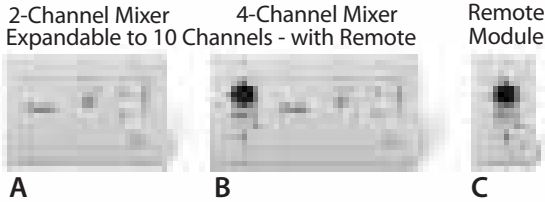

### A Complete Sound System Ideal For:

- Conference Rooms
- Meeting Rooms
- Restaurants
- Institutional Cafeterias
- Lecture Halls
- Auditoriums
- Sporting Complexes
- Gymnasiums

## In-Wall Modular Mixer

### Channel Mixers (Common Features: V-9983-W & V-9985-W)

- Built-In Compressor (Option Switch Controlled) for Automatic Consistent Volume Level Adjustment Even When Voices Vary - Low to High
- Master Volume Control for Optimum Volume Adjustments & Volume Control for Each Input
- 1 General Building Page Input (-10dBm) Overrides All Others
- Drives 50 Amplified Speakers/Horns
- 8 Segment LED Meter for Visual Indication of Audio Signal Levels
- Full Frequency Range Output for Speakers
- High Pass Output Horn Filter

### Remote Module

- Provides 1 Balanced XLR Microphone Input & 1 Auxiliary Input for MP3 Players, CD, DVD or PC's
- Connects to Main Control Module, w/2 Pair 24 AWG Cable
- Volume Control for Each Input
- Power "ON" Indicator
- Phantom Power (Switch Controlled) w/"ON" Indicator Allows Use of Consumer Microphone

## 6 Channel Amplifier

- 6 Independent Channels of Amplification
- 4 (Four) 10 Watt Outputs/2 (Two) 40 Watt Outputs
- Quick Release Screw Terminals
- Activity Led Indicators
- High Pass Horn Filter on 40 Watt Outputs
- Independent Volume Controls for Each Channel
- Power Indicator
- Transformer Coupled Inputs
- 115 - 250 Vac



| Analog Managing Sound |  | VPU |
|-----------------------|--|-----|
| <b>A</b>              | 2 Channel In-Wall Mixer <i>White</i> ..... V-9983-W<br>Mounts in 3-Gang Electrical Box<br>4.25"H x 5"W x 2"D (10.80cm x 12.7cm x 5.08cm) 0.4lbs (0.18kg)   | -1  |
| <b>B</b>              | 4 Channel In-Wall Mixer <i>White</i> ..... V-9985-W<br>Mounts in 4-Gang Electrical Box<br>4.25"H x 5"W x 2"D (10.80cm x 12.7cm x 5.08cm) 0.6lbs (0.27kg)   | -1  |
| <b>C</b>              | In-Wall Remote Module <i>White</i> ..... V-9984-W<br>Mounts in 1-Gang Electrical Box<br>4.25"H x 1.64"W x 2"D (10.80cm x 4.17cm x 5.08cm) 0.25lbs (0.11kg) | -1  |
| <b>D</b>              | 6 Channel Amplifier (70 Volt) ..... V-6120<br>3.5"H x 17.0"W x 15.0"D (8.89cm x 43.18cm x 38.1cm) 21.0lbs (9.53kg)   | 0   |

## Eliminate Feedback

### Digital Stacking Feedback Eliminator

*Eliminate Busy Signals On Heavily Used Paging Systems/Prevents Acoustic Feedback*

- Multiple Messages Recorded Simultaneously
- Stacks Messages - Records a Page While Playing One
- One Unit Eliminates Feedback to ALL Zones
- Automatic Consistent Volume Level Even When Recording Voices Vary - Low to High
- High-Fidelity - Voice Sounds Natural Not Like A Recording
- LED Indicators for Play, Record, Busy, Power
- Dipswitch Features: Pre-Announce Alert Tone, Priority Override (Real Time or Delayed), DTMF Message Cancel
- Real Time Background Music Input w/Volume Control
- Two Audio Outputs: 8 & 600 ohms
- Emergency Messages Can Interrupt Play Back Sequence
- Power Requirements: -24Vdc, 250mA

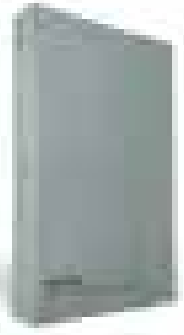

## Background Music

### Message-On-Hold USB Devices

*A Solid-State Digital Message Repeater Installs Easily Into Any Messaging Application That Requires Triggered, Continuous or Timed Message Play*

- Messages & MP3 Files are Stored on 16MB - 4GB USB Flash Drives
- Playback Quality Up to 128Kbps
- Built-In Monitor Speaker
- LED Status Indicator
- Store Up to 99 Messages
- Triggered and/or Timed Playback
- Active Output Indication Trigger
- Auxiliary 12VDC Output for Wiring Sensors
- Power Supply Included



| Analog Feedback & Background Music |   | VPU |
|------------------------------------|---|-----|
| <b>E</b>                           | Stacking Feedback Eliminator ..... V-9964<br>11.76"H x 7.10"W x 1.72"D (29.87cm x 18.03cm x 4.37cm) 2.6lbs (1.18kg) | -6  |
| <b>F</b>                           | USB Multi-Messenger Device ..... V-9989<br>5.1"H x 6.03"W x 1.75"D (12.95cm x 15.32cm x 4.45 cm) 2.4lbs (1.08kg)    | 0   |
| <b>G</b>                           | USB Message-On-Hold Device ..... V-9988<br>5.1"H x 6.03"W x 1.75"D (12.95cm x 15.32cm x 4.45cm) 2.1lbs (1.04kg)     | 0   |

### Auxiliary Relay Units for Strobe Activation, Door Control, Camera Control

- Three 24Vdc 2 Pole Relays with 1 Amp Contacts
- Screw Terminals for All Connections
- Independent Control or Simultaneous Operation of Relays
- Expandable to 6 Relays by Adding V-9957 Expansion Board

| Analog Auxiliary Relay Units |  | VPU |
|------------------------------|--|-----|
| No Pic.                      | Auxiliary Relay Unit ..... V-9955<br>11.76"H x 7.10"W x 1.72"D (29.87cm x 18.03cm x 4.37cm) 2.6lbs (1.18kg)                                  | 0   |
| No Pic.                      | Auxiliary Relay Expansion Unit (for use with the V-9955) ... V-9957<br>5.1"H x 6.03"W x 1.75"D (12.95cm x 15.32cm x 4.45 cm) 2.4lbs (1.08kg) | 0   |



## Alerting

### Loud Warble Ringer Horn

- 90VAC Ring or 18VAC Buzzer Voltage Activation
- Connects Directly to PBX Station
- Built-In Tone Generator, 5-Watt Amplifier, & Volume Control
- Power Requirements: -24Vdc, 500mA Activate with 90Vac, 18Vac

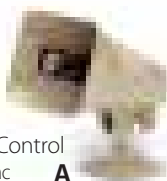
**A**

| Analog Ringer Horns |   | VPU            |
|---------------------|---|----------------|
| <b>A</b>            | Loud Warble Ringer Horn.....V-9925A<br>6.50"H x 8.20"W x 10.40"D (16.51cm x 20.83cm x 26.42cm) 3.6lbs (1.63kg)                                    | -10            |
|                     | Single Tone Warble Horn Power Supply Included .....V-9945A<br>6.50"H x 8.20"W x 10.40"D (16.51cm x 20.83cm x 26.42cm) 4.3lbs (1.95kg) FCC Part 15 | Power Included |

Flash of Light to Get Attention in Noisy Areas Where Paging Can't be Heard

### IP Strobe PoE

- 15,30,75,95,110 Candella - User Selectable
- Activate on SIP Call
- Can Activate Multiple Strobes Via Single SIP Call
- Activate on Group Audio

**B**

### Strobe ADA Compliant

110 Candela of Brilliancy Strobe, Covers 70 ft by 70 ft Area

- Flash Rate is Designed to Comply with ADA
- Power Supply Included Mount Strobe 80 Inches Above Floor
- Activated by Applying Power, Dry Contact Closure, 70 Volt Speaker Voltage

**C**

**CAUTION: DO NOT USE 2 STROBES WITHIN SAME FIELD OF VIEW**

| Analog Strobe |  | IP SoundPoints® |
|---------------|--|-----------------|
| <b>B</b>      | IP Strobe.....VPU<br>5.57"H x 4.68"W x 2.75"D (14.15cm x 11.89cm x 6.99cm)<br>0.70lb (0.315kg)                   | VIP-999         |
| <b>C</b>      | ADA Compliant Strobe.....V-5580041B<br>5.63"H x 4.63"W x 4.50"D (14.29cm x 11.75cm x 11.43cm)<br>1.4lbs (0.64kg) | 0               |

## LED Signs



### LED Scrolling Signs

The IP PoE Visual Message Display is Utilized for Broadcasting Visual and Voice Message Alerts Including Daily or Emergency Alerts

- RJ45 for Network Connection
- Activity LED
- Network Activity LEDs
- IP Set Up for Configuration
- Browser Set Up for Messages
- Static or DHCP Configurable
- Supervised and Monitoring Capabilities
- Visual Message Maybe Programmed for One or Two Lines with Options for Color, Transitions and Fonts
- API Available
- Built-in CAP Receiver Option

| IP SoundPoints® |  |
|-----------------|--|
| <b>D</b>        | 5" High x 30" Wide<br>IP LED Scrolling Sign.....VL530A<br>IP LED Scrolling Sign, InformaCast®.....VL530A-IC  |
| <b>E</b>        | 6.25" High x 33" Wide<br>IP LED Scrolling Sign w/ Speakers.....VL550A<br>IP LED Scrolling Sign w/ Speakers, InformaCast®.....VL550A-IC                                 |
| <b>F</b>        | 7.75" High x 33" Wide<br>IP LED Scrolling Sign w/ Speakers & Flashing Light.....VL550AF<br>IP LED Scrolling Sign w/ Speakers & Flashing Light, InformaCast® VL550AF-IC |

## Add Tones Over Paging

Visit Our Website to Hear Tones, Bells & Warbles

### Tone Generators

#### Multi-Tone Generator

**G**

Up To 8 Different Tones with a Single Unit: Choice of 2 Sets of 8 Different Tones

- Siren Evacuation\* - Steady Shift Changes\* - Chime Doorbutton/Code Call
- Whoop Tornado\* - Burst Alarm Signal\* - Dual Chime Doorbell Ring
- Warble Fire\* - TeleBell Auxiliary Ring \* USA Standard Immediate Evacuation Signals

- Contact Closure Activation • Automatically Overrides Page or Music

#### C.O. Line Audible Ring Unit – 6 Lines

- 90Vac Ring or Dry Contact Closure Activation
- Connects Directly up to 6 C.O. or PBX Station Lines
- Ringing Over Paging Speakers
- Contact Closure Output to Activate Loud Bells
- Automatically Overrides Page or Music
- Built-In Warble Tone Generator
- Specifications: Output: 8 ohm; Power Requirements: -24Vdc, 200mA

#### C.O. Line Audible Ring Unit – 1 Line

- 90Vac, 18Vac, or Dry Contact Closure Activation
- Connects to Analog PBX Station Port
- Ringing Over Paging Speakers
- Provides 3 Separate Zone Outputs & Volume Controls for Use w/One-Way or Talkback Page Controls
- Automatically Overrides Page or Music
- Power Requirements: -24Vdc, 300mA

#### Code Call Unit For Security/Priority - Tones May Be Better Than Voice

- Use In Hospitals - When Voice Announcements Are Not Wanted
- Use In Department Stores - Does Not Distract Customers
- Contact Closure Output to Activate Loud Bells
- Up to 81 Two-Digit Codes or 729 Three-Digit Codes
- Power Requirements: -24Vdc, 300mA

| Analog Add Tones Over Paging |   | VPU |
|------------------------------|---|-----|
| <b>G</b>                     | Multi-Tone Generator.....V-9927A<br>8.20"H x 4.55"W x 2.30"D (20.83cm x 11.56cm x 5.84cm) 1.5lbs (0.68kg)     | -2  |
| <b>H</b>                     | 6 Line Audible Ring Unit.....V-9936A<br>8.20"H x 4.55"W x 2.30"D (20.83cm x 11.56cm x 5.84cm) 1.5lbs (0.68kg) | -4  |
| <b>I</b>                     | C.O. Audible Ringer.....V-9924C<br>8.20"H x 4.55"W x 2.30"D (20.83cm x 11.56cm x 5.84cm) 1.3lbs (0.59kg)      | -6  |
| <b>J</b>                     | Code Call Unit.....V-9923B<br>7.1"H x 5.9"W x 2.1"D (18.03cm x 14.99cm x 5.33cm) 3.0lbs (1.35kg)              | -4  |

# Dial Select Intercoms — 24 - 360 Zones

Ideal for Schools, Institutions, Industrial, Healthcare Facilities, Airports



## DualPath

**Expandable Intercom System up to 96 Zones**

**A 24 Zones**  
*One-Way or Talkback*  
 Wall Mount ..... V-2924A  
 17.5"H x 10.31"W x 3.06"D (44.45cm x 26.19cm x 7.77cm) 17.5 lbs (7.9kg)

**B Expansion Unit**  
 • Expand in 24 Zone Increments  
 • Three V-2925's may be added to V-2924 for up to 96 zones  
 Wall Mount ..... V-2925A  
 17.5"H x 8.37"W x 3.06"D (44.45cm x 21.26cm x 7.77cm) 13.5 lbs (6.13kg)

- All Call/Group Call/Emergency Override Call
- Background Music Input
- Class of Service/Zone
- Door Unlock Control
- SMDR Printer Port
- Tone Inputs
- Caller ID
- UL, CSA, CE

**FXO Telephone Access**  
 PBX Loop Start Trunk Port  
 Electronic Key Line Position  
 Dedicated Single Line Phone Set

**Accessories:**

- Option Card Easy Plug In** for Remote Laptop Programming..... V-2926
- Clock Control Card** for use with V-2928..... V-2927
- Option Card** with Time Event Scheduling Software..... V-2928
- Option Card** with Time Event Scheduling Software and Synch Wire Clock Connection... V-CLK2924
- Clock Relay Card** for use with V-2927 Clock Control Card..... V-CIO

## MultiPath

**Expandable Intercom System up to 360 Zones**

**C 24 Zones**  
*One-Way*  
 Wall Mount ..... V-PW24  
 Rack Mount ..... V-PR24  
*Talkback*  
 Wall Mount ..... V-TW24  
 Rack Mount ..... V-TR24

**48 Zones**  
*One-Way*  
 Wall Mount ..... V-PW48  
 Rack Mount ..... V-PR48  
*Talkback*  
 Wall Mount ..... V-TW48  
 Rack Mount ..... V-TR48

**72 Zones**  
*One-Way*  
 Rack Mount ..... V-PR72  
*Talkback*  
 Rack Mount ..... V-TR72

**96 Zones**  
*One-Way*  
 Rack Mount ..... V-PR96  
*Talkback*  
 Rack Mount ..... V-TR96

**Accessories:** System Cards

- 24 Point One-Way Intercom Expansion Board..... V-STX
- 24 Point Talkback Intercom Expansion Board..... V-TCM
- Universal Relay Interface ..... V-URI
- System CPU Board w/2 V-SLC Cards (4 Links)..... V-CPU4





## D Round Ceiling Speakers

*Industry Recognized for Exceptional Performance for Voice & Music!*

- White Epoxy Finish, Custom Colors -CC
- Mounting Hardware - See Page 11

## E Square Ceiling or Wall Speaker

*Industry Recognized for Exceptional Performance for Voice & Music!*

- White Epoxy Finish, Custom Colors -CC

## F Lay-In Ceiling Speakers™ w/Backbox

*Easy Lay-In Installation Replaces a 2' x 2' Tile*

- Lightweight - Weighs Slightly More Than a 2' x 2' Ceiling Tile!
- Save Time, Effort & Money - Get On & Off the Job Quickly
- No Cutting Tiles, No Broken Tiles, No Mess
- Excellent Music & Voice Quality
- Durable White Acrylic Baked Enamel Finish, Custom Colors -CC
- Integral Backbox Meets or Exceeds ASTM E84 Flame & Smoke Test w/3 Hour Burn Rating

**Optional Trim Bar** Use to Install in a 2 x 4 Ceiling Tile (10 Pack) ..... V-TBAR  
24.5"H x 1.0"W x 1.0"D (62.23cm x 2.54cm x 2.54cm) 3.5lbs (1.58kg)

## G Metal Wall Speaker

- 8" Speaker, Excellent Voice & Music Quality
- Easy Installation, Screw Terminal Connections
- Black Cloth Grille, Gray Paintable Metal Housing, Custom Colors -CC

## H Black or White Wall Speakers

- 8" Speaker, Excellent Voice & Music Quality
- Easy Installation
- Black or White Simulated Woodgrain

## I Woodgrain Wall Speaker

- 8" Speaker, Excellent Voice & Music Quality
- Easy Installation
- Light Brown Woodgrain, Open-Weave Grille

## J FlexHorn™ — Rugged Speaker

- Low Ceilings Such as Light Manufacturing or Multi-Floor Warehouses
- Low to Moderate Noise Environments
- Water-Proof for Environments Requiring Direct Spray Down Such as Car Washes, Food Processing Plants, & Operating Rooms
- Adjustable Mounting Bracket Included (V-9804)  
Mount on Wall, Ceiling or Beam

## Talkback Speakers

|          |  |
|----------|--|
| <b>D</b> | <b>Round Ceiling Speaker</b> Colors: White (Paintable), Custom Colors -CC<br>8" Round Ceiling Speaker Talkback (6 Pack) ... 4 Volume Tap Settings ..... V-C806PK<br>13" Dia x 2.5"D (33.02cm x 6.35cm) 17.8lbs (8.01kg)<br>8" Round Ceiling Speaker Talkback 4 Volume Tap Settings ..... VC-1060A<br>13" Dia x 2.5"D (33.02cm x 6.35cm) 3.3lbs (1.49kg)  |
| <b>E</b> | <b>Square Ceiling Speaker</b> Colors: White (Paintable), Custom Colors -CC<br>8" Square Ceiling Speaker Talkback (6 Pack) ... 4 Volume Tap Settings ..... V-CTSQPK<br>11.5"H x 11.5"W x 3.9"D (29.21cm x 29.21cm x 9.91cm) 3.5lbs (1.58kg)   |
| <b>F</b> | <b>Lay-In Ceiling Speaker</b> Colors: White (Paintable), Custom Colors -CC<br>2' x 2' Lay-In Ceiling Speaker Talkback 4 Volume Tap Settings ..... VC-9062<br>23.75"L x 23.75"W x 3.75"D (60.33cm x 60.33cm x 9.53cm) 8.3lbs (3.74kg)<br>2' x 2' Lay-In Ceiling Speaker Talkback (2 Pack) ... 4 Volume Tap Settings ..... V-CTLA-2<br>23.75"H x 23.75"W x 3.75"D (60.33cm x 60.33cm x 9.53cm)<br>8.5lbs (3.83kg); For 2 Pack: 14lbs (6.3kg) |
| <b>G</b> | <b>Metal Wall Speaker</b> Colors: Gray (Paintable), Custom Colors -CC<br>Metal Wall Speaker Talkback 4 Volume Tap Settings ..... V-WTGY<br>9.6"H x 11.5"W x 4.2"D (24.38cm x 29.21cm x 10.67cm) 5lbs (2.25kg)  |
| <b>H</b> | <b>Black &amp; White Wall Speaker</b><br>Black Wall Speaker Talkback 4 Volume Tap Settings ..... VC-1061-BK<br>White Wall Speaker Talkback 4 Volume Tap Settings ..... VC-1061-W<br>9.6"H x 11.5"W x 4.2"D (24.38cm x 29.21cm x 10.67cm) 4.3lbs (1.94kg)   |
| <b>I</b> | <b>Woodgrain Wall Speaker</b><br>Woodgrain Wall Speaker Talkback 4 Volume Tap Settings ..... VC-1062A<br>10.6"H x 9.7"W x 5.2"D (26.92cm x 24.64cm x 13.21cm) 5.3lbs (2.39kg)  |
| <b>J</b> | <b>FlexHorn™</b> Colors: Beige-BGE, Gray-GY, or White-W<br>FlexHorn Talkback 4 Volume Tap Settings ..... VC-1090<br>6.8"H x 8.3"W x 3.3"D (17.27cm x 21.08cm x 8.38cm) 2.7lbs (1.22kg)   |

## MultiPath Accessories

|  |           |
|--|-----------|
| <b>Accessories</b>   |           |
| Program Distribution Panel .....                             | V-PDP     |
| SLIC Card - 2 Telephone Interface Circuits .....             | V-SLC     |
| Music - AM/FM CD Control Panel .....                         | V-RDP     |
| One-Way Paging Adapter .....                                 | V-LPT     |
| Clock Control Interface Package .....                        | V-CLK     |
| <b>Option Cards</b>  |           |
| Large LED Display Package .....                              | V-DSP     |
| Serial Card .....  | V-SER     |
| <b>Mounting Racks</b>  |           |
| Mounting Rack - 9 Position Card Cage Rack Mount .....        | V-MCRK    |
| Mounting Rack - 4 Position Wall Mount Rack .....             | V-MWRK    |
| <b>Backplane Cables</b>                                      |           |
| Backplane Cable - 4 Position Feature Cards .....             | VC40R-4   |
| Backplane Cable/Terminator - 8 Position Feature Cards .....  | VC40R-8T  |
| Backplane Cable/Terminator - 9 Position Feature Cards .....  | VC40R-9T  |
| Backplane Cable/Terminator - 16 Position Feature Cards ..... | VC40R-16T |
| <b>Call-In Switch</b>  |           |
| Emergency/Normal - Stainless Steel .....                     | V-2970    |
| Rocker Push Button - Stainless Steel (6 Pack) .....          | V-2972PK  |
| <b>Power Supply</b>  |           |
| 6 Amp Positive 24 Vdc - Wall Mount .....                     | V-C6124P  |

# Valcom SIP HelpPoints

## Tower Emergency Telephones

*With a single press of a button, those in distress are provided two-way connection with security personnel.*



## Parking Lots, Athletic Fields, Pathways

### Vandal-Resistant IP Emergency Call Tower

*IP Emergency Telephone with Mass Notification Broadcast Unique, Contemporary Style — Sleek*

- Full SIP Functionality – Multi SIP Servers
- Compatible with Cisco, Avaya & Most Modern IP Telephone Systems
- Call Button Calls a SIP Address or Any Valcom Gateway Device
- Provides Enhanced Caller ID
- Automatic Talkback Operation (no Push-to-Talk Button Required)
- SIP or Multicast Addressable
- Messaging Broadcast Capability
- Unlimited Simultaneous Group Calls
- High Intensity LED Blue Flashing Light
- LED Lighted Call Button
- Supervision with Alert Functions
- Vandal and Tamper-Resistant
- Rugged, Low Power, Lightweight – Only 75 Pounds

► **Options:**

- Fiber
- PoE & Powered
- 115 – 240 Volts
- Managed Headend Switch
- Solar Powered
- Camera
- WiFi
- 4G LTE
- Colors and Markings
- Multi Buttons - 2, 3 or 4

| A Valcom SIP HelpPoints   |           |
|---|-----------|
| <b>Tower Emergency Telephone</b>  |           |
| IP Emergency Call Tower .....   | VE9811    |
| IP Emergency Call Tower, <i>InformaCast</i> ® .....                       | VE9811-IC |
| <small>114"H x 10" Dia. Approx. (289.56cm x 25.4cm) 75lb (32.7kg)</small> |           |
| <i>Call for configuration assistance &amp; pricing.</i>                   |           |



B

## Exterior Wall or Pole Mount SIP HelpPoint

*Provides High Visible Security for Hallways, Transit Centers, Building/Dorm Entrance & Parking Decks*

### SIP Vandal-Resistant Emergency Call Station

- Easy, RJ-45 Plug-in, CAT 5 or 6
- Call Button Calls a SIP Address or Any Valcom Gateway Device
- SIP or Multicast Addressable
- Red LED Status Indicator
- Network Programmable for Control and Setup
- Door Opening Contact Provided
- Automatic Talkback VOX Operation (No Push-to-Talk Button Needed)
- Compatible with Most Modern IP Telephone Systems
- Blue Flashing Light
- Provides High Visible Security for Hallways, Transit Centers, Building/Dorm Entrance & Parking Decks
- Surface or Pole Mount

**B Emergency Call Station** .....VIP-9895  
*InformaCast*® .....VIP-9895-IC



C

### SIP Multi-Button Emergency/Information Call Station

- 2, 3 or 4 Call Programmable Call Buttons  
 - Emergency, General, Directions, Recorded Information
- Emergency Calls Take Precedence Over All Other Calls
- Convenient "Voice Operated Switch" VOX Operated
- Surface or Pole Mount

**C Multi-Button Call Station** .....VIP-9894  
*InformaCast*® .....VIP-9894-IC

*Available in: Red, Blue, Yellow, Gray and Stainless Steel.  
 Call for configuration assistance & pricing.*



D

### Interior SIP Call Station w/Paging Horn

### SIP Vandal-Resistant Emergency Call Station

- Loud Horn for Large Areas

### SIP Vandal-Resistant Call Station

- Door Relay Connection
- Surface Mount Steel Enclosure
- Stainless Steel Faceplate
- Call Button
- Long Line Extender



E

| Valcom SIP HelpPoints |  |
|-----------------------|--|
| <b>D</b>              | <b>Vandal-Resistant Emergency Call Station</b><br>IP Call Station .....VIP-9890A-EM<br>IP Call Station <i>Long Line Extender</i> .....VIP-9890AL-EM<br>10.0"H x 12.5"W x 4"D (25.4cm x 31.75cm x 10.2cm) 10.75lbs (4.89kg)                       |
| <b>E</b>              | <b>Vandal-Resistant Call Station</b><br>IP Intercom/Doorphones .....VIP-9890AL-CB<br>10.0"Hx12.5"Wx4"D (25.4cm x 31.75cm x 10.2cm) 10.75lbs (4.89kg)<br>To Order Color: Yellow-Y, Blue-B, or Gray-G, Add Color Suffix (Ex: VE-9890AL-#-Y Yellow) |

### IP Emergency Call Station

- In-Wall Recessed - Interior Use Only

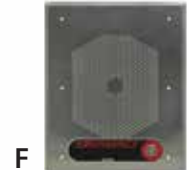

F

**F IP Emergency Call Station** .....VIP-9896

### IP Repurpose Emergency Call Plate

*Allows Retrofit of Existing Analog Emergency Telephone Enclosures to Provide Advanced IP Features such as Page Broadcasts, All Call and Monitoring*

*(Ex; Code Blue, Talk-A-Phone, Gai-tronics)*

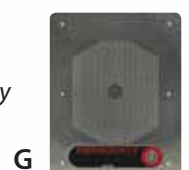

G

| Valcom SIP HelpPoints |   |
|-----------------------|---|
| <b>G</b>              | <b>IP Repurpose Emergency Call Plate</b> .....VE9870A<br><br>Call for configuration assistance & pricing. |

# Clocks *Proven Time-Keeping Accuracy & Reliability*



## IP PoE Clocks

### Analog

- A** 12-Inch.....VIP-A12A  
12.81"Dia x 1.2"D (32.54cm x 3.05cm) 3.7lbs (1.67kg)
- B** 16-Inch.....VIP-A16A  
16.81"Dia x 1.6"D (42.70cm x 4.06m) 5.35lbs (2.41kg)
- Double-Sided**
- A** 12-Inch.....VIP-A12ADS  
12.81"Dia x 7.00"D (32.54cm x 17.78cm) 11.00lbs (4.99kg)
- B** 16-Inch.....VIP-A16ADS  
16.81"Dia x 7.25"D (42.70cm x 18.42cm) 12.6lbs (5.72kg)

### Digital

**4-Digit:** **HH:MM**

- D** 2.5-Inch Numbers.....VIP-D425A  
10.65"H x 3.0"W x 4.9"D (27.05cm x 7.62cm x 12.45cm) 2.88lbs (1.30kg)
- E** 4.0-Inch Numbers.....VIP-D440A  
17"H x 3.0"W x 6.75"D (43.18cm x 7.62cm x 17.15cm) 4.5lbs (2.03kg)
- 4-Digit Double-Sided**
- D** 2.5-Inch Numbers.....VIP-D425ADS  
11.5"H x 4.25"W x 5.5"D (29.21cm x 10.80cm x 13.97cm) 5.9lbs (2.66kg)
- E** 4.0-Inch Numbers.....VIP-D440ADS  
17.38"H x 4.25"W x 6.85"D (44.15cm x 10.80cm x 17.40cm) 9.1lbs (4.10kg)

**6-Digit:** **HH:MM:SS**

- F** 2.5-Inch Numbers.....VIP-D625A  
15.3"H x 3.0"W x 4.9"D (38.87cm x 7.62cm x 12.45cm) 3.85lbs (1.73kg)
- G** 4.0-Inch Numbers.....VIP-D640A  
24.5"H x 3.0"W x 6.75"D (62.23cm x 7.62cm x 17.15cm) 6.0lbs (2.7kg)
- 6-Digit Double-Sided**
- F** 2.5-Inch Numbers.....VIP-D625ADS  
16.12"H x 4.25"W x 5.5"D (40.94cm x 10.80cm x 13.97cm) 7.3lbs (3.29kg)
- G** 4.0-Inch Numbers.....VIP-D640ADS  
25.25"H x 4.25"W x 6.85"D (64.134cm x 10.80cm x 17.40cm) 12.0lbs (5.4kg)

Double-Sided comes with Mounting Bracket/Hardware. (Except for VIP-D425ADS). To Attach to Ceiling Tile use V-9914M-5 Bridge - See page 11.

## Wireless Clocks

### Analog

- A** 12-Inch, Battery Operated.....V-AW12B
- C** 12-Inch, Military Dial.....V-AW12B-MD
- A** 12-Inch, 110Vac/24Vdc.....V-AW12BLP  
12.65"Dia x 2.18"D (32.13cm x 5.54cm) 2.5lbs (1.13kg)
- B** 16-Inch, Battery Operated.....V-AW16B
- 16-Inch, 110Vac/24Vdc.....V-AW16BLP**  
16.65"Dia x 2.18"D (42.29cm x 5.54cm) 4.0lbs (1.81kg)

### Digital

**4-Digit:** **HH:MM**

- D** 2.5-Inch Numbers, 110Vac.....V-DW11025B  
11.06"L x 5.35"W x 3.90"D (28.09cm x 13.59cm x 9.90cm) 2.0lbs (0.90kg)
- E** 4.0-Inch Numbers, 110Vac.....V-DW11040B  
14.10"L x 7.56"W x 3.86"D (35.80cm x 19.20cm x 9.80cm) 3.5lbs (1.58kg)

## Wired Clocks

### Analog

- A** 12-Inch, 24Vdc.....V-A2412B
- 12-Inch, 110Vac.....V-A11012B  
12.81"Dia x 1.2"D (32.54cm x 3.05cm) 3.1lbs (1.41kg)
- B** 16-Inch, 24Vdc.....V-A2416B
- 16-Inch, 110Vac.....V-A11016B  
16.65"Dia x 1.6"D (42.29cm x 4.06 cm) 4.9lbs (2.22kg)

### Digital

**4-Digit:** **HH:MM**

- D** 2.5-Inch Numbers, 24Vdc.....V-D2425B  
10.31"L x 4.69"W x 3.90"D (26.19cm x 11.91cm x 9.90cm) 1.3lbs (0.59kg)
- E** 4.0-Inch Numbers, 24Vdc.....V-D2440B  
13.31"L x 6.75"W x 3.86"D (33.81cm x 17.15cm x 9.80cm) 3.5lbs (1.59kg)

► **Analog Accessories**

**Double-Sided Brackets** for Wireless Clocks  
 12-Inch Analog Clocks..... V-WMB-12  
 16-Inch Analog Clocks..... V-WMB-16



**Double-Sided Brackets** for Wired Clocks  
 12-Inch Analog Clocks..... V-BDM12-S  
 16-Inch Analog Clocks..... V-BDM16-S



**Surface Mounting** for Wired Clocks  
 12-Inch Clocks..... V-SMR12A  
 16-Inch Clocks..... V-SMR16A

**Wire Guards**  
**Analog** for 12 & 16" Analog Clocks..... V-WGACLK  
 20.19"L x 23.24"W x 5.24"D (57.28cm x 59.02cm x 13.30cm)



► **Digital Accessories**

**Double-Sided Brackets**  
 for 4-Digit Digital Clocks..... V-DMKIT



**Wire Guards**  
 for 4-Digit Digital Clocks..... V-WGD4  
 20.75"L x 9.0"W x 5.0"D (52.71cm x 22.86cm x 12.7cm)

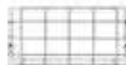

**Clock Controls & Drivers**

**Master Clock Transceiver**..... V-WMCA  
 11"L x 17.5"W x 1.75"D (27.94cm x 44.45cm x 4.45cm) 6.5lbs (2.90kg)

**Repeater**..... V-WMCRA  
*Must be used with a V-DCPI Digital Clock Protocol Interface, a V-GPSA GPS Receiver or a V-WMCA Wireless Master Clock*  
 11"L x 8"W x 1.7"D (27.94cm x 20.32cm x 4.32cm) Antenna: 7" (17.78cm) 4lbs (1.8kg)

**Digital Clock Protocol Interface**..... V-DCPI

**GPS Master Clock Wireless**..... V-GPS-TX  
 Using Valcom Wireless Clocks, Add a Wireless Master Clock Repeater (V-WMCRA)

**Wired**..... V-GPSA  
 Using Valcom Wired Clock (2-Wire correction), Add 6-Amp 2-Wire Clock Driver (V-VCU)  
 11"H x 17.5"W x 1.75"D (27.94cm x 44.45cm x 4.45cm) 6.5lbs (2.90kg)

**Drivers**  
**Clock Driver — 6-Amp, 2-Wire**..... V-VCU  
 2.63"H x 12.36"W x 7.75"D (6.7cm x 31.4cm x 19.7cm) 7lbs (3.2kg) with power supply  
**Digital Clock Head End Driver, 2-Wire**..... V-DCH

**IP Clock Speakers & Backboxes**



A



B



C



D





E

**IP Clock Speakers**

**A Flush Mount - Analog** Colors: White, Custom Colors -CC  
 One-Way or Talkback Programmable.....VIP-429A-A  
 14.50"H x 13.00"W x 3.40"D (36.93cm x 33.02cm x 8.64cm) 4.8 lbs(2.17kg)



**B Flush Mount - Digital** Colors: White, Custom Colors -CC  
**6-Digit: HH:MM:SS**  
 One-Way or Talkback Programmable.....VIP-426A-D

**C 4-Digit: HH:MM**  
 One-Way, InformaCast®.....VIP-419A-D-IC  
 One-Way or Talkback Programmable.....VIP-429A-D  
 Talkback, InformaCast®.....VIP-429A-D-IC  
 14.50"H x 13.00"W x 3.40"D (36.93cm x 33.02cm x 8.64cm) 4.8 lbs (2.17kg)

► **Backboxes for A, B, C**  
**Surface Mount**..... VB-S23   
 14.63"H x 13.00"W x 3.94"D  
**Recessed Mount**..... VB-R22   
 13.25"H x 11.25"W x 3.94"D  
**Angled Mount**..... VB-A24   
 14.41"H x 13.00"W x 5.00"D [t] x 3.00"D [b]

**IP Clock Speakers**

**D Flush Mount - Digital** Colors: Gray, Custom Colors -CC  
**4-Digit: HH:MM**  
 One-Way or Talkback Programmable Gray.....VIP-432A-DF  
 One-Way, InformaCast® Gray.....VIP-412A-DF-IC  
 Talkback, InformaCast® Gray.....VIP-432A-DF-IC  
 20.28"H x 14.38"W x 4.50"D (51.5cm x 36.53cm x 11.43cm) 4.25lbs (1.91kg)

► **Backboxes for D**  
**Surface Mount**..... VB-S20   
 20.18"H x 14.27"W x 6.27"D  
**Recessed Mount**..... VB-R19   
 19.25"H x 10.75"W x 3.75"D  
**Angled Mount**..... VB-A21   
 19.88"H x 14.27"W x 6.27"D [t] x 2.72"D [b]

**E Angled Surface Mount - Digital** Colors: Gray, Custom Colors -CC  
 (No Backbox Required)  
**4-Digit: HH:MM**  
 One-Way or Talkback Programmable.....VIP-431A-DS  
 Talkback, InformaCast®.....VIP-431A-DS-IC  
 15.0"H x 12.25"W x 4.0"D [t] 1.45"D [b] (38.1cm x 31.1cm x 10.2cm D [t] 3.7cm [b] 4.25lbs (1.91kg)

# Speaker & Clock Speaker Assemblies

## ► Choose 8-Inch Speaker Assemblies:

**24V Speaker (w/Amplifier)**  
 VSA-1020C -1  
 8.0"Dia x 2.25"D (20.32cm x 5.72cm)  
 2.5lbs (1.13kg)



**24V**

**45 Ohm Talkback (4 Volume)**  
 V-936418 0  
 8.0"Dia x 2.75"D (20.32cm x 6.99cm)  
 1.3 lbs (0.59 kg)



**45 Ohm**

**25/70 Volt**  
 V-936400 0  
 8.0"Dia x 2.25"D (20.32cm x 5.72cm)  
 1.7lbs (.77kg)



**25/70 Volt**

### ► Choose Your Faceplate:

#### Square Grille

- Designed for Mounting 8-Inch Speaker Assembly
- Hardware Included

Colors: White (Paintable), Custom Colors -CC .....V-936480



### ► Choose Your Backbox:



#### ANGLED

VB-A13

11.54"H x 11.63"W x 4.60"D[t] x 3.15"D[b]  
 Grille Hole Dimns.: 10.00" x 10.00"



#### RECESSED

VB-R12

10.75"H x 10.75"W x 3.94"D  
 Grille Hole Dimns.: 10.00" x 10.00"



#### SURFACE

VB-S11

11.63"H x 11.63"W x 3.94"D  
 Grille Hole Dimns.: 10.00" x 10.00"

### ► Choose Your Vandal-Resistant Faceplate:

#### Vandal-Resistant Faceplate:

Heavy Gauge Steel Construction

Colors: Gray (Paintable), Custom Colors -CC .....V-9808



### ► Choose Your Vandal-Resistant Backbox & Faceplate:

#### Vandal-Resistant Enclosure & Faceplate:

Heavy Gauge Steel Construction

Colors: Gray (Paintable), Custom Colors -CC ..... V-9807



### ► Choose Your Clock Speaker Faceplate:

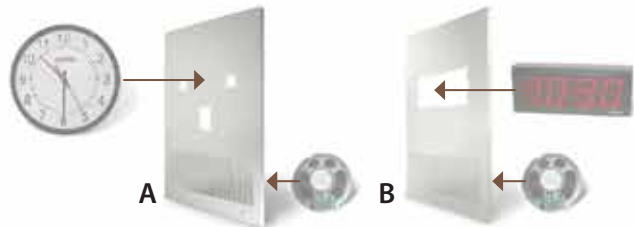

**A Analog Baffle** for 12-Inch Clock & 8-Inch Speaker .....V-CSB12S  
 Color: White, Light Texture Powder Paint  
 20.32"H x 14.41"W x .56"D (51.44cm x 36.53cm x 1.42cm) 2.4lbs (1.09kg)

**B Digital Baffle** for 4 Digit, 2.5-Inch Clock & 8-Inch Speaker ...V-CSB25  
 Color: White, Light Texture Powder Paint  
 20.25"H x 14.38"W x .56"D (51.44cm x 36.53cm x 1.42cm) 2.4lbs (1.09kg)

### ► Choose Your Backbox:

Surface Mount

Recessed Mount

Angled Mount



**C Surface Mount** .....VB-S20  
 20.81"H x 14.27"W x 2.78"D (52.86cm x 36.25cm x 7.06cm) 4.2lbs (1.91kg)

**D Recessed Mount** .....VB-R19  
 19.25"H x 10.75"W x 3.75"D (48.89cm x 27.31cm x 9.53cm) 4.0lbs (1.81kg)

**E Angled Mount** .....VB-A21  
 19.88"H x 14.27"W x 6.27"D[t] x 2.72"D[b]

Color: White, Light Texture Powder Paint

## Backbox Selection Chart

| Part No. | Mount Style | Dimensions                                | For Use With  |
|----------|-------------|---|---|
| VB-S11   | Surface     | 11.63"H x 11.63"W x 3.94"D                | VIP-428A, VIP-428A-IC, V-CTSQPK, V-936480, V-1920C, V-1921, V-1961  |
| VB-R12   | Recessed    | 10.75"H x 10.75"W x 3.94"D                | VIP-428A, VIP-428A-IC, V-CTSQPK, V-936480, V-1920C, V-1921, V-1961  |
| VB-A13   | Angled      | 11.63"H x 11.63"W x 4.60"D                | VIP-428A, VIP-428A-IC, V-CTSQPK, V-936480, V-1920C, V-1921, V-1961  |
| VB-R17-D | Recessed    | 9.63"H x 9.63"W x 5.94"D                  | VIP-9880A, VIP-9880A-IC   |
| VB-R19   | Recessed    | 19.25"H x 10.75"W x 3.75"D                | VIP-431A-A-IC, VIP-432A-DF, VIP-432A-DF-IC, VIP-412A-DF-IC          |
| VB-S20   | Surface     | 19.25"H x 10.75"W x 3.75"D                | VIP-431A-A-IC, VIP-432A-DF, VIP-432A-DF-IC, VIP-412A-DF-IC          |
| VB-A21   | Angled      | 19.88"H x 14.27"W x 6.27"D[t] x 2.72"D[b] | VIP-431A-A-IC, VIP-432A-DF, VIP-432A-DF-IC, VIP-412A-DF-IC          |
| VB-R22   | Recessed    | 13.25"H x 11.25"W x 3.75"D                | VIP-419A-D-IC, VIP-429A-A, VIP-429A-A-IC, VIP-429A-D-IC, VIP-426A-D |
| VB-S23   | Surface     | 14.63"H x 13.13"W x 3.94"D                | VIP-419A-D-IC, VIP-429A-A, VIP-429A-A-IC, VIP-429A-D-IC, VIP-426A-D |
| VB-A24   | Angled      | 14.48"H x 13.13"W x 5.00"D[t] x 2.97"D[b] | VIP-419A-D-IC, VIP-429A-A, VIP-429A-A-IC, VIP-429A-D-IC, VIP-426A-D |



*Specializing in unique software and hardware solutions to address daily and emergency communication needs.*

**K-12 Schools**



**Colleges & Universities**



**Transportation**



**Large Industrial Complexes**



**Hospitals/Healthcare**



**Multi-Site Enterprise and Chains**



**For Consultation for Valcom Engineered Solutions, contact us at 1.877.427.2166 or 1.540.563.2000 or via email to [esd@valcom.com](mailto:esd@valcom.com).**

# Index

Description Part # VPU Page #

## ANALOG PAGE CONTROLS

### 2000 Series

#### 1 Zone ◆■▲

One-Way ..... V-2000A +12.....8

#### 1 Zone Enhanced ◆■▲

One-Way ..... V-2001A +20.....8

One-Way European Version ..... V-2001A-E +20.....8

#### 3 Zones ◆■▲

One-Way ..... V-2003A +10.....8

One-Way European Version ..... V-2003A-E +10.....8

Talkback ..... V-2003AHF +20.....8

Talkback European Version ..... V-2003AHF-E +20.....8

#### 6 Zones ◆■▲

One-Way ..... V-2006A +30.....8

One-Way European Version ..... V-2006A-E +30.....8

Talkback ..... V-2006AHF +20.....8

Talkback European Version ..... V-2006AHF-E +20.....8

### Analog Page Control

PBX Loop Start Trunk, Electronic Key Line, Single Line Phone

#### 1 Zone ◆

Talkback ..... V-9941A .....-6.....8

#### Station Level/FXS Adapters

#### 1 Zone ●

For use with One-Way Controllers ..... V-9970 .....-4.....8

For use with One-Way or Talkback Controllers ..... V-9940 .....-4.....8

PagePal Interface ◆■▲● ..... V-5335700 .....0.....8

## SIP PAGING

1 Zone Analog/Plus 8 Zones SIP Station/100 Zone SIP TrunkVIP-201A .....9

4 Zone Analog/Plus 8 Zones SIP Station/100 Zone SIP TrunkVIP-204A .....9

SIP 20W Gateway 25V ..... VIP-851-25 .....9

SIP 20W Gateway 25V/70/100V ..... VIP-851-70/100 .....9

### Audio Ports (Line Level -10dbm)

1 Audio Port ..... VIP-801A .....9

1 Audio Port InformaCast® ..... VIP-801A-IC .....9

2 Audio Ports ..... VIP-802A .....9

4 Audio Ports ..... VIP-804A .....9

### FXS Ports (Station Ports)

1 FXS Port ..... VIP-811A .....9

2 FXS Ports ..... VIP-812A .....9

4 FXS Ports ..... VIP-814A .....9

### FXO Ports (Loop Start)

1 FXO Port ..... VIP-821A .....9

2 FXO Ports ..... VIP-822A .....9

4 FXO Ports ..... VIP-824A .....9

## CEILING SPEAKERS

#### 2' x 2'

One-Way (2 Pack) ..... V-9022A-2 .....-1.. 10

One-Way European Version ..... V-9022-EC .....-1..10

One-Way Dual-Input ..... V-9028 .....-1.. 10

IP One-Way SECURE ..... VIP-402A ..... 10

IP One-Way SECURE InformaCast® ..... VIP-402A-IC ..... 10

IP One-Way European Version ..... VIP-402A-EC ..... 10

Talkback ..... V-9062 .....0.. 10

IP Talkback ..... VIP-422A ..... 10

IP Talkback, InformaCast® ..... VIP-422A-IC ..... 10

#### 1' x 2'

One-Way ..... V-9021 .....+1.. 10

Accessories: Trim T-Bar (10 Pack) ..... V-TBAR ..... 10

#### Large Round

One-Way SECURE ..... V-1020C .....-1.. 11

IP One-Way SECURE ..... VIP-120A ..... 11

IP One-Way SECURE InformaCast® ..... VIP-120A-IC ..... 11

Description Part # VPU Page #

One-Way Dual-Input ..... V-1220 .....-1.. 11

Talkback ..... V-1060A .....0.. 11

IP Talkback ..... VIP-160A ..... 11

IP Talkback InformaCast® ..... VIP-160A-IC ..... 11

#### Accessories for Mounting:

Speaker Bridge (5 Pack) ..... V-9914M-5 ..... 11

Pre-Construction Bridge (10 Pack) ..... V-9912M-10 ..... 11

Post-Const. Mounting Ring (12 Pack) ..... V-9912P-12 ..... 11

Backbox (5 Pack) ..... V-9915M-5 ..... 11

Bridge/Backbox Combo ..... V-9916M ..... 11

#### Small Round

One-Way ..... V-1010C .....-1.. 11

#### Accessories for Mounting:

Speaker Bridge (5 Pack) ..... V-9904M-5 ..... 11

Backbox (5 Pack) ..... V-9915M-5 ..... 11

#### Square Ceiling (Round Hole Pattern)

One-Way ..... V-1920C .....-1.. 11

Talkback (6 Pack) ..... V-CTSQPK .....0.. 11

#### Square Ceiling (Square Hole Pattern)

One-Way ..... V-1921 .....-1.. 11

IP One-Way or Talkback Programmable ..... VIP-428A ..... 11

IP One-Way, InformaCast® ..... VIP-418A-IC ..... 11

Talkback ..... V-1961 .....0.. 11

IP Talkback, InformaCast® ..... VIP-428A-IC ..... 11

#### Accessories for Mounting:

Surface Mount ..... VB-S11 ..... 11

Recessed Mount ..... VB-R12 ..... 11

Angled Mount ..... VB-A13 ..... 11

#### P-Tec™

One-Way ..... V-1001 .....-1.. 12

Talkback ..... V-1070 .....0.. 12

#### Pendant

One-Way Black Grill ..... V-1015B .....-6.. 12

One-Way White with White Grill ..... V-1015B-WW .....-6.. 12

#### Accessory:

Additional Six Foot Chain ..... V-1093BK ..... 12

#### Clean Room

One-Way ..... V-1040 .....-1.. 12

IP One-Way or Talkback Programmable ..... VIP-140A ..... 12

#### Surface Mount

One-Way ..... V-9010-W .....-1.. 12

## HIGH-FIDELITY SPEAKERS

#### Signature Series Lay-In

One-Way ..... V-1422 .....-4.. 13

Accessories: Trim T-Bar (10 Pack) ..... V-TBAR ..... 13

#### Signature Series Ceiling

One-Way ..... V-1420 .....-4.. 13

Accessories: HiFi Bridge & Backbox ..... V-9816M ..... 13

#### Signature Series Monitor

One-Way ..... V-1440 .....-4.. 13

Accessories: Optional Wall Mounting Bracket ..... V-9804 ..... 13

Accessories: Wire Cage (2 Pack) ..... V-WGWALL-2 ..... 13

#### Signature Series In-Wall

One-Way ..... V-1450 .....-4.. 13

## WALL SPEAKERS

#### Slimline™

One-Way ..... V-1042 .....-1.. 14

Talkback ..... V-1046 .....0.. 14

Accessories: Wire Cage (2 Pack) ..... V-WGWALL-2 ..... 14

#### Desktop/Wall

One-Way ..... V-763 .....-1.. 14

Talkback ..... V-762 .....0.. 14

Talkback w/Push Button ..... V-764 .....0.. 14

#### Track-Style

1-Watt One-Way Black Grill ..... V-1013B .....-1.. 14

| Description  | Part #      | VPU | Page # |
|--|-------------|-----|--------|
| <b>1-Watt One-Way</b> <i>White with White Grille</i> .....       | V-1013B-WW  | -1  | 14     |
| <b>5-Watt One-Way</b> .....                                      | V-1014B     | -6  | 14     |
| <b>Metal Wall</b>  |             |     |        |
| <b>One-Way</b> .....   | V-1052C     | -1  | 15     |
| <b>IP One-Way or Talkback</b> <i>Programmable</i> .....          | VIP-430A    |     | 15     |
| <b>IP One-Way, InformaCast®</b> .....                            | VIP-410A-IC |     | 15     |
| <b>Talkback</b> .....  | V-1071      | 0   | 15     |
| <b>IP Talkback, InformaCast®</b> .....                           | VIP-430A-IC |     | 15     |
| <b>Accessories: Wire Cage (2 Pack)</b> .....                     | V-WGWALL-2  |     | 15     |
| <b>Metal Corner</b>  |             |     |        |
| <b>One-Way</b> .....   | V-1054      | -1  | 15     |
| <b>Talkback</b> .....  | V-1055      | 0   | 15     |
| <b>Square Wall Speaker</b>                                       |             |     |        |
| <b>One-Way</b> .....   | V-1921      | -1  | 15     |
| <b>IP One-Way or Talkback</b> <i>Programmable</i> .....          | VIP-428A    |     | 15     |
| <b>IP One-Way, InformaCast®</b> .....                            | VIP-418A-IC |     | 15     |
| <b>Talkback</b> .....  | V-1961      | 0   | 15     |
| <b>IP Talkback, InformaCast®</b> .....                           | VIP-428A-IC |     | 15     |
| <b>Accessories for Mounting:</b>                                 |             |     |        |
| <b>Surface Mount</b> .....                                       | VB-S11      |     | 15     |
| <b>Recessed Mount</b> .....                                      | VB-R12      |     | 15     |
| <b>Angled Mount</b> .....  | VB-A13      |     | 15     |
| <b>Light Woodgrain Angled Wall Open-Weave Grille</b>             |             |     |        |
| <b>One-Way</b> .....   | V-1022C     | -1  | 16     |
| <b>One-Way, Dual-Input</b> .....                                 | V-1222      | 0   | 16     |
| <b>Light Woodgrain Bi-Directional Corridor Open-Weave Grille</b> |             |     |        |
| <b>One-Way</b> .....   | V-1026C     | -1  | 16     |
| <b>Black Wall</b>  |             |     |        |
| <b>One-Way</b> .....   | V-1016-BK   | -1  | 16     |
| <b>Talkback</b> .....  | V-1061-BK   | 0   | 16     |
| <b>White Wall</b>  |             |     |        |
| <b>One-Way</b> .....   | V-1016-W    | -1  | 16     |
| <b>Talkback</b> .....  | V-1061-W    | 0   | 16     |
| <b>White Bi-Directional Corridor</b>                             |             |     |        |
| <b>One-Way</b> .....   | V-1026C-W   | -1  | 16     |
| <b>Dark Woodgrain Angled Wall Cloth Grille</b>                   |             |     |        |
| <b>One-Way</b> .....   | V-1023C     | -1  | 16     |
| <b>Talkback</b> .....  | V-1063A     | 0   | 16     |
| <b>Accessory for Mounting:</b>                                   |             |     |        |
| <b>Wire Cage (2 Pack)</b> .....                                  | V-WGWALL-2  |     | 16     |

**VANDAL-RESISTANT SPEAKERS**

|   |             |    |    |
|---|-------------|----|----|
| <b>Vandal-Resistant Wall Speaker</b>                    |             |    |    |
| <b>One-Way</b> .....                                    | V-9852      | -1 | 17 |
| <b>Talkback</b> .....                                   | V-9871      | 0  | 17 |
| <b>FlexHorn™ Surface Mount Unit</b>                     |             |    |    |
| <b>One-Way</b> .....                                    | V-9880      | -3 | 17 |
| <b>Talkback</b> .....                                   | V-9890      | 0  | 17 |
| <b>IP One-Way or Talkback</b> <i>Programmable</i> ..... | VIP-580A    |    | 17 |
| <b>IP One-Way, InformaCast®</b> .....                   | VIP-580A-IC |    | 17 |
| <b>FlexHorn™ Dual Surface Mount Unit</b>                |             |    |    |
| <b>One-Way</b> .....                                    | V-9885      | -6 | 17 |
| <b>FlexHorn™ Angled Surface Mount Unit</b>              |             |    |    |
| <b>IP One-Way or Talkback</b> <i>Programmable</i> ..... | VIP-581A    |    | 17 |
| <b>IP One-Way, InformaCast®</b> .....                   | VIP-581A-IC |    | 17 |

**HIGH-EFFICIENCY HORNS**

|   |                  |     |    |
|---|------------------|-----|----|
| <b>5-Watt, One-Way</b> <i>Beige</i> .....                 | V-1030C          | -5  | 18 |
| <b>5-Watt, IP One-Way</b> <i>Beige</i> .....              | VIP-130AL-BGE    |     | 18 |
| <b>5-Watt, IP One-Way InformaCast®</b> <i>Beige</i> ..... | VIP-130AL-BGE-IC |     | 18 |
| <b>5-Watt, One-Way</b> <i>Gray</i> .....                  | V-1030C-GY       | -5  | 18 |
| <b>5-Watt, IP One-Way</b> <i>Gray</i> .....               | VIP-130AL-GY     |     | 18 |
| <b>5-Watt, IP One-Way InformaCast®</b> <i>Gray</i> .....  | VIP-130AL-GY-IC  |     | 18 |
| <b>15-Watt, One-Way</b> <i>Beige</i> .....                | V-1036C          | -15 | 18 |
| <b>15-Watt, One-Way</b> <i>Gray</i> .....                 | V-1036C-GY       | -15 | 18 |

| Description   | Part #                   | VPU | Page # |
|---|--------------------------|-----|--------|
| <b>Talkback</b> <i>Beige or Gray</i> .....                          | VIP-148AL-BGE (-GY)      |     | 18     |
| <b>Talkback InformaCast®</b> <i>Beige or Gray</i> .....             | VIP-148AL-BGE-IC (GY-IC) |     | 18     |
| <b>IP Talkback</b> <i>Beige</i> .....                               | VIP-148AL-BGE            |     | 18     |
| <b>IP Talkback InformaCast®</b> <i>Gray</i> .....                   | VIP-148AL-GY-IC          |     | 18     |
| <b>Marine Horn</b> <i>Marine White</i>                              |                          |     |        |
| <b>5-Watt, One-Way</b> .....  | V-1030M                  | -5  | 18     |
| <b>5-Watt, IP One-Way</b> .....                                     | VIP-130AL-M              |     | 18     |
| <b>5-Watt, IP One-Way InformaCast®</b> .....                        | VIP-130AL-M-IC           |     | 18     |
| <b>15-Watt, One-Way</b> .....                                       | V-1036M                  | -15 | 18     |
| <b>Talkback</b> .....   | V-1048M                  | 0   | 18     |
| <b>IP Talkback</b> .....  | VIP-148AL-M              |     | 18     |
| <b>IP Talkback InformaCast®</b> .....                               | VIP-148AL-M-IC           |     | 18     |
| <b>30-Watt, One-Way</b> <i>Beige</i> * Use 48VDC Power Supply ..... | V-1038                   | *   | 18     |
| <b>Accessories: Wire Cage (2 Pack)</b> .....                        |                          |     |        |
|   | V-WGHORN-2               |     | 18     |
| <b>Bi-Directional Horn</b>  |                          |     |        |
| <b>One-Way</b> <i>Beige</i> .....                                   | V-1050C                  | -6  | 18     |
| <b>Explosion-Proof Horn</b>   |                          |     |        |
| <b>One-Way</b> <i>Gray</i> .....                                    | V-1039A                  | -20 | 18     |
| <b>Talkback</b> <i>Gray</i> .....                                   | V-1069A                  | 0   | 18     |

**FLEXHORNS**

|  |               |    |    |
|--|---------------|----|----|
| <b>Stealth FlexHorn</b>  |               |    |    |
| <b>One-Way</b> .....   | V-9830        | -3 | 19 |
| <b>IP One-Way</b> .....  | VIP-9831A     |    | 19 |
| <b>Stealth Speaker Corridor Surface Mount</b>                          |               |    |    |
| <b>One-Way</b> .....   | V-9815        | -3 | 19 |
| <b>IP One-Way or Talkback</b> <i>Programmable</i> .....                | VIP-9815A     |    | 19 |
| <b>IP One-Way InformaCast®</b> .....                                   | VIP-9815AL-IC |    | 19 |
| <b>FlexHorns™</b>  |               |    |    |
| <b>One-Way</b> .....   | V-1080        | -3 | 19 |
| <b>IP One-Way</b> .....  | VIP-480AL     |    | 19 |
| <b>IP One-Way InformaCast®</b> .....                                   | VIP-480AL-IC  |    | 19 |
| <b>Talkback</b> .....  | V-1090        | 0  | 19 |
| <b>IP Talkback</b> .....   | VIP-490AL     |    | 19 |
| <b>IP Talkback InformaCast®</b> .....                                  | VIP-490AL-IC  |    | 19 |
| <b>Mounting Options:</b>   |               |    |    |
| <b>Adjustable Mounting Bracket</b> <i>Included with FlexHorn</i> ..... | V-9804        |    | 19 |
| <b>Wire Cage</b> .....   | V-WGFLEX-2    |    | 19 |
| <b>Make FlexHorns Vandal-Resistant:</b>                                |               |    |    |
| <b>Stainless Steel Enclosure &amp; Faceplate</b> .....                 | V-9805        |    | 19 |
| <b>Stainless Steel Faceplate</b> .....                                 | V-9806        |    | 19 |
| <b>Heavy Gauge Steel Enclosure &amp; Faceplate</b> .....               | V-9809        |    | 19 |
| <b>FlexHorn™ Square Surface Mount Faceplate</b>                        |               |    |    |
| <b>IP One-Way or Talkback</b> <i>Programmable</i> .....                | VIP-9880A     |    | 19 |
| <b>IP One-Way, InformaCast®</b> .....                                  | VIP-9880A-IC  |    | 19 |
| <b>Accessory for Mounting:</b>   |               |    |    |
| <b>Recessed Mount</b> .....  | VB-R17-D      |    | 19 |

**POWER SUPPLIES**

|   |             |      |    |
|---|-------------|------|----|
| <b>300mA/24V</b> .....  | VP-324D     | +6   | 20 |
| <b>IP 300mA/24V</b> .....   | VIP-324D    |      | 20 |
| <b>600mA/24V</b> .....  | VP-624D     | +12  | 20 |
| <b>1 Amp/24V</b> .....  | VP-1124D    | +20  | 20 |
| <b>1 Amp/24V UK Version</b> .....                                       | VP-1124D-UK | +20  | 20 |
| <b>2 Amp/24V</b> .....  | VP-2124D    | +40  | 20 |
| <b>2 Amp/24V European Version</b> .....                                 | VP-2124D-EC | +40  | 20 |
| <b>2 Amp/24V UK Version</b> .....                                       | VP-2124D-UK | +40  | 20 |
| <b>2 Amp/-48V</b> <i>For the V-1038, 30-Watt Horn, page 18</i> .....    | VP-2148D    | NA   | 20 |
| <b>4 Amp/24V</b> .....  | VP-4124D    | +80  | 20 |
| <b>4 Amp/24V European Version</b> .....                                 | VP-4124D-EC | +80  | 20 |
| <b>6 Amp/24V</b> .....  | VP-6124     | +120 | 20 |
| <b>6 Amp/ 230 VAC /.86A; 165W European Version</b> .....                | VP-6124-E   | +120 | 20 |
| <b>Accessory:</b>   |             |      |    |
| <b>Power Supply Shelf</b> <i>Holds Two VP-6124 Power Supplies</i> ..... | VP-9202     |      | 20 |
| <b>12 Amp/24V</b> .....   | VP-12124    | +240 | 20 |
| <b>400mA/12V Unfiltered</b> .....                                       | VP-412A     | NA   | 20 |
| <b>Battery Back-Up Power</b> .....                                      | VPB-260     | NA   | 20 |
| <b>Battery Back-Up Charger</b> .....                                    | VP-6124-UPS | 0    | 20 |
| <b>Battery Box with Batteries</b> .....                                 | VBB-1424    | 0    | 20 |

# Index

Description Part # VPU Page #

## INTERCOM/DOOR ENTRY

**SIP Talkback Stainless Steel** ..... VIP-176 ..... 21  
**Optional:** Hi Security Smart Relay for Door Latches ..... VM-SRLY ..... 21

**Doorplate Speakers Vandal-Resistant**

**Talkback White** ..... V-1073 ..... 0 21  
**IP Talkback w/LED Stainless Steel** ..... VIP-172AL-VRSS ..... 21

**Doorplate Speakers Brass**

**Talkback** ..... V-1072A-BRASS ..... 0 21  
**IP Talkback** ..... VIP-172AL-BRASS ..... 21  
**Talkback w/LED** ..... V-1072B-BRASS ..... 0 21

**Doorplate Speakers Stainless Steel**

**Talkback** ..... V-1072A-ST ..... 0 21  
**IP Talkback** ..... VIP-172AL-ST ..... 21  
**Talkback w/LED** ..... V-1072B-ST ..... 0 21

**Accessories:**

Doorbox Weather Guard - Black ..... V-9910-BK ..... 21  
 Doorbox Weather Guard - Yellow ..... V-9910-YEL ..... 21

**Door Answering Devices**

Single Door Answer & Unlock Control ..... V-2901A ..... -12 21  
 Four Door Answer & Unlock Control ..... V-2904 ..... -12 21  
 Single Door Answering Control ..... V-2900 ..... 0 21

## ENHANCEMENTS

Spot SoundMasking Speaker - 2' x 2' Lay-In Ceiling ..... V-9422 ..... NA 22

**Volume Control Sensors**

Noise Sensing Volume Control ..... V-9933A ..... -2 22  
 Remote Microphone ..... V-9934 ..... NA 22

**Call-In Switches**

Call-In Switch w/Volume Control Stainless Steel ..... V-2971 ..... 0 22  
 Call-In Switch w/Volume Control White ..... V-2991-W ..... 0 22  
 Emergency/Normal w/Volume Control, Stainless Steel ..... V-2970 ..... 0 22  
 Emergency/Normal w/Volume Control, White ..... V-2995-W ..... 0 22  
 Call-In Switch w/Privacy Switch ..... V-9320 ..... 0 22  
 Rocker Push Button Stainless Steel ..... V-2972PK ..... 0 22  
 Emergency Vandal-Resistant, Red ..... V-2976 ..... 0 22

**Speaker Volume Controls**

Speaker Volume Control Stainless Steel ..... V-1092 ..... 0 22  
 Speaker Volume Control w/o Single Gang Box, Stainless Steel ..... V-1092B ..... 0 22  
 Speaker Volume Control White ..... V-2992-W ..... 0 22  
 Speaker Volume Control w/Slide Switch Stainless Steel ..... V-1097 ..... 0 22

**Microphone Panel with Stored Messages**

Stored Message/Mic Page Panel ..... V-9908 ..... -5 23  
 Audio Interface ..... V-1096 ..... 0 23

**Microphones**

Desk Paging Microphone ..... V-400 ..... 0 23  
 Dynamic Noise Canceling Microphone ..... V-420 ..... 0 23  
 Gooseneck Microphone ..... V-450 ..... 0 23  
 Microphone Adapter ..... V-9939C ..... -1 23

**Line Transformers / 70 Volt Expander**

Input Line Matching Transformer ..... VMT-1 ..... NA 23  
 Audio Isolation Transformer ..... VMT-2 ..... NA 23  
 70 Volt Expander Stainless Steel ..... V-1095 ..... 0 23

**Paging Expansion**

Page Port PreAmp/Expander Stainless Steel ..... V-1094A ..... -1 23  
 Page Port PreAmp/Expander w/o Single Gang Box, Stainless Steel ..... V-1094B ..... -1 23  
 Page Port PreAmp/Expander White ..... V-2994-W ..... -1 23

**Mixers**

2 Channel In-Wall Mixer White ..... V-9983-W ..... -1 24  
 4 Channel In-Wall Mixer White ..... V-9985-W ..... -1 24  
 In-Wall Remote Module White ..... V-9984-W ..... -1 24

6 Channel Amplifier (70 Volt) ..... V-6120 ..... 0 24

**Eliminate Feedback/Background Music**

Stacking Feedback Eliminator ..... V-9964 ..... 6 24  
 USB Multi-Messenger Device ..... V-9989 ..... 0 24  
 USB Message-On-Hold Device ..... V-9988 ..... 0 24

Description Part # VPU Page #

**Ringer Horns**

Loud Warble Ringer Horn ..... V-9925A ..... -10 25  
 Single Tone Warble Horn ..... V-9945A ..... -PI 25

**Strobes**

IP Strobe ..... VIP-999 ..... 25  
 Strobe ..... V-5580041B ..... 25

**Auxiliary Relay Units**

Auxiliary Relay Unit ..... V-9955 ..... 24  
 Auxiliary Relay Expansion Unit (for use with the V-9955) ..... V-9957 ..... 24

**IP PoE LED Scrolling Signs**

5" H x 30" W ..... VL530A ..... 25  
 5" H x 30" W InformaCast® ..... VL530A-IC ..... 25  
 6.25" H x 33" W with Speakers ..... VL550A ..... 25  
 6.25" H x 33" W with Speakers InformaCast® ..... VL550A-IC ..... 25  
 7.75" H x 33" W with Speakers & Flashing Light ..... VL550AF ..... 25  
 7.75" H x 33" W w/ Speakers & Flashing Light InformaCast® ..... VL550AF-IC ..... 25

**Add Tones Over Paging**

Multi-Tone Generator ..... V-9927A ..... -2 25  
 6 Line Audible Ring Unit ..... V-9936A ..... -4 25  
 C.O. Audible Ringer ..... V-9924C ..... -6 25  
 Code Call Unit ..... V-9923B ..... -4 25

## DIAL SELECT INTERCOMS

**Dual Path**

24 Zones One-Way or Talkback Wall Mount ..... V-2924A ..... 26  
 Expansion Unit Expand in 24 Zone Increments Wall Mount ..... V-2925A ..... 26

**Accessories:**

**Option Card Easy Plug-In for Remote Laptop Programming** V-2926 ..... 26  
**Clock Control Card for use with V-2928** ..... V-2927 ..... 26  
**Option Card Time Event Scheduling Software** ..... V-2928 ..... 26  
**Option Card Time Event Scheduling Software, Synch Wire** V-CLK2924 ..... 26  
**Clock Relay Card for use with V-2927 Clock Control Card** ..... V-CIO ..... 26

**MultiPath**

**24 Zones One-Way Wall Mount** ..... V-PW24 ..... 26  
**24 Zones One-Way Rack Mount** ..... V-PR24 ..... 26

**24 Zones Talkback Wall Mount** ..... V-TW24 ..... 26  
**24 Zones Talkback Rack Mount** ..... V-TR24 ..... 26

**48 Zones One-Way Wall Mount** ..... V-PW48 ..... 26  
**48 Zones One-Way Rack Mount** ..... V-PR48 ..... 26

**48 Zones Talkback Wall Mount** ..... V-TW48 ..... 26  
**48 Zones Talkback Rack Mount** ..... V-TR48 ..... 26

**72 Zones One-Way Rack Mount** ..... V-PR72 ..... 26  
**72 Zones Talkback Rack Mount** ..... V-TR72 ..... 26

**96 Zones One-Way Rack Mount** ..... V-PR96 ..... 26  
**96 Zones Talkback Rack Mount** ..... V-TR96 ..... 26

**Accessories: System Cards**

24 Point One-Way Intercom Expansion Board ..... V-STX ..... 26  
 24 Point Talkback Intercom Expansion Board ..... V-TCM ..... 26  
 Universal Relay Interface ..... V-URI ..... 26  
 System CPU Board w/2 V-SLC Cards (4 Links) ..... V-CPU4 ..... 26

**MultiPath Speakers**

8" Round Ceiling Speaker Talkback (6 Pack) ..... V-C806PK ..... 27  
 8" Round Ceiling Speaker Talkback ..... VC-1060A ..... 27  
 8" Square Ceiling Speaker Talkback (6 Pack) ..... V-CTSQPK ..... 27  
 2' x 2' Lay-In Ceiling Speaker Talkback ..... VC-9062 ..... 27  
 2' x 2' Lay-In Ceiling Speaker Talkback (2 Pack) ..... V-CTLA-2 ..... 27  
 Optional Trim Bar Use to Install in a 2 x 4 Ceiling Tile (10 Pack) ..... V-TBAR ..... 27  
 Metal Wall Speaker Talkback ..... V-WTGY ..... 27  
 Black Wall Speaker Talkback ..... VC-1061-BK ..... 27  
 White Wall Speaker Talkback ..... VC-1061-W ..... 27  
 Woodgrain Wall Speaker Talkback ..... VC-1062A ..... 27  
 FlexHorn™ Talkback ..... VC-1090 ..... 27

**Mounting Options:**

Adjustable Mounting Bracket Included with FlexHorn ..... V-9804 ..... 27

**MultiPath Accessories:**

Program Distribution Panel ..... V-PDP ..... 27

| Description  | Part #    | VPU | Page # |
|--|-----------|-----|--------|
| SLIC Card - 2 Telephone Interface Circuits             | V-SLC     |     | 27     |
| Music - AM/FM CD Control Panel                         | V-RDP     |     | 27     |
| One-Way Paging Adapter                                 | V-LPT     |     | 27     |
| Clock Control Interface Package                        | V-CLK     |     | 27     |
| Large LED Display Package                              | V-DSP     |     | 27     |
| Serial Card  | V-SER     |     | 27     |
| Mounting Rack - 9 Position Card Cage Rack Mount        | V-MCRK    |     | 27     |
| Mounting Rack - 4 Position Wall Mount Rack             | V-MWRK    |     | 27     |
| Backplane Cable - 4 Position Feature Cards             | VC40R-4   |     | 27     |
| Backplane Cable/Terminator - 8 Position Feature Cards  | VC40R-8T  |     | 27     |
| Backplane Cable/Terminator - 9 Position Feature Cards  | VC40R-9T  |     | 27     |
| Backplane Cable/Terminator - 16 Position Feature Cards | VC40R-16T |     | 27     |
| <b>MultiPath Call-In Switch</b>                        |           |     |        |
| Emergency/Normal - Stainless Steel                     | V-2970    |     | 27     |
| Rocker Push Button - Stainless Steel (6 Pack)          | V-2972PK  |     | 27     |
| <b>MultiPath Power Supply</b>                          |           |     |        |
| 6 Amp Positive 24 Vdc - Wall Mount                     | V-C6124P  |     | 27     |

## EMERGENCY HELP POINTS

Available in Multiple Styles and/or Colors - Contact Valcom 1-540-563-2000

|  |               |    |
|--|---------------|----|
| <b>Tower Emergency Telephone</b>               | VE9811        | 28 |
| InformaCast®                                   | VE9811-IC     | 28 |
| <b>Emergency Call Station</b>                  | VIP-9895      | 29 |
| InformaCast®                                   | VIP-9895-IC   | 29 |
| <b>Multi-Button Call Station</b>               | VIP-9894      | 29 |
| InformaCast®                                   | VIP-9894-IC   | 29 |
| <b>Vandal-Resistant Emergency Call Station</b> |               |    |
| IP Call Station                                | VIP-9890A-EM  | 29 |
| IP Call Station Long Line Extender             | VIP-9890AL-EM | 29 |
| <b>Vandal-Resistant Call Station</b>           |               |    |
| IP Intercom/Doorphones                         | VIP-9890AL-CB | 29 |
| <b>IP Emergency Call Station</b>               | VIP-9896      | 29 |
| <b>IP Repurpose Emergency Call Plate</b>       | VE9870A       | 29 |

## CLOCKS

|  |             |    |  |
|--|-------------|----|--|
| <b>IP PoE Clocks</b>                                 |             |    |  |
| 12-Inch Analog                                       | VIP-A12A    | 30 |  |
| 16-Inch Analog                                       | VIP-A16A    | 30 |  |
| 12-Inch Analog Double-Sided                          | VIP-A12ADS  | 30 |  |
| 16-Inch Analog Double-Sided                          | VIP-A16ADS  | 30 |  |
| <b>4-Digit 2.5-Inch Numbers Digital</b>              | VIP-D425A   | 30 |  |
| <b>4-Digit 4.0-Inch Numbers Digital</b>              | VIP-D440A   | 30 |  |
| <b>4-Digit 2.5-Inch Numbers Digital Double-Sided</b> | VIP-D425ADS | 30 |  |
| <b>4-Digit 4.0-Inch Numbers Digital Double-Sided</b> | VIP-D440ADS | 30 |  |
| <b>6-Digit 2.5-Inch Numbers Digital</b>              | VIP-D625A   | 30 |  |
| <b>6-Digit 4.0-Inch Numbers Digital</b>              | VIP-D640A   | 30 |  |
| <b>6-Digit 2.5-Inch Numbers Digital Double-Sided</b> | VIP-D625ADS | 30 |  |
| <b>6-Digit 4.0-Inch Numbers Digital Double-Sided</b> | VIP-D640ADS | 30 |  |
| <b>Wireless Clocks</b>                               |             |    |  |
| 12-Inch Analog, Battery Operated                     | V-AW12B     | 30 |  |
| 12-Inch Analog, Military Dial                        | V-AW12B-MD  | 30 |  |
| 12-Inch Analog, 110Vac/24Vdc                         | V-AW12BLP   | 30 |  |
| 16-Inch Analog, Battery Operated                     | V-AW16B     | 30 |  |
| 16-Inch Analog, 110Vac/24Vdc                         | V-AW16BLP   | 30 |  |
| <b>4-Digit 2.5-Inch Numbers Digital</b>              | V-DW11025B  | 30 |  |
| <b>4-Digit 4.0-Inch Numbers Digital</b>              | V-DW11040B  | 30 |  |
| <b>Wired Clocks</b>                                  |             |    |  |
| 12-Inch Analog, 24Vdc                                | V-A2412B    | 30 |  |
| 12-Inch Analog, 110Vac                               | V-A11012B   | 30 |  |
| 16-Inch Analog, 24Vdc                                | V-A2416B    | 30 |  |
| 16-Inch Analog, 110Vac                               | V-A11016B   | 30 |  |
| <b>4-Digit 2.5-Inch Numbers Digital 24Vdc</b>        | V-D2425B    | 30 |  |
| <b>4-Digit 4.0-Inch Numbers Digital 24Vdc</b>        | V-D2440B    | 30 |  |

| Description  | Part #         | VPU    | Page # |
|--|----------------|--------|--------|
| <b>Analog Accessories</b>                                |                |        |        |
| <b>Wireless Double-Sided Brackets</b>                    |                |        |        |
| 12-Inch Analog Clocks                                    | V-WMB-12       | 31     |        |
| 16-Inch Analog Clocks                                    | V-WMB-16       | 31     |        |
| <b>Wired Double-Sided Brackets</b>                       |                |        |        |
| 12-Inch Analog Clocks                                    | V-BDM12-S      | 31     |        |
| 16-Inch Analog Clocks                                    | V-BDM16-S      | 31     |        |
| <b>Surface Mounting</b>                                  |                |        |        |
| 12-Inch Clocks   | V-SMR12A       | 31     |        |
| 16-Inch Clocks   | V-SMR16A       | 31     |        |
| <b>Wire Guards Analog for 12 &amp; 16" Analog Clocks</b> | V-WGACLK       | 31     |        |
| <b>Digital Accessories</b>                               |                |        |        |
| <b>Double-Sided Brackets 4-Inch Digital Clock</b>        | V-DMKIT        | 31     |        |
| <b>Wire Guard Digital for 4-Inch Digital Clock</b>       | V-WGD4         | 31     |        |
| <b>Master Clock</b>                                      |                |        |        |
| Transceiver  | V-WMCA         | 31     |        |
| Repeater   | V-WMCRA        | 31     |        |
| Clock Protocol Interface                                 | V-DCPI         | 31     |        |
| <b>GPS Master Clock</b>                                  |                |        |        |
| Wireless   | V-GPS-TX       | 31     |        |
| Wired  | V-GPSA         | 31     |        |
| <b>Drivers</b>   |                |        |        |
| Clock Driver - 6-Amp, 2-Wire                             | V-VCU          | 31     |        |
| Digital Clock Head End Driver, 2-Wire                    | V-DCH          | 31     |        |
| <b>IP Clock/Speakers</b>                                 |                |        |        |
| <b>Flush Mount - Analog Gray</b>                         |                |        |        |
| <b>IP One-Way or Talkback Programmable</b>               | VIP-429A-A     | 31     |        |
| <b>Flush Mount - Digital White</b>                       |                |        |        |
| 6-Digits One-Way or Talkback Programmable                | VIP-426A-D     | 31     |        |
| 4-Digits IP One-Way, InformaCast®                        | VIP-419A-D-IC  | 31     |        |
| 4-Digits One-Way or Talkback Programmable                | VIP-429A-D     | 31     |        |
| 4-Digits IP Talkback, InformaCast®                       | VIP-429A-D-IC  | 31     |        |
| <b>Angled Surface Mount - Digital Gray</b>               |                |        |        |
| 4-Digits One-Way or Talkback Programmable                | VIP-431A-DS    | 31     |        |
| 4-Digits IP Talkback, InformaCast®                       | VIP-431A-DS-IC | 31     |        |
| <b>Backboxes</b>   |                |        |        |
| <b>Surface Mount</b>                                     | VB-S23         | 31     |        |
| <b>Recessed Mount</b>                                    | VB-R22         | 31     |        |
| <b>Angled Mount</b>                                      | VB-A24         | 31     |        |
| <b>Flush Mount - Digital Gray</b>                        |                |        |        |
| 4-Digits One-Way or Talkback Programmable                | VIP-432A-DF    | 31     |        |
| 4-Digits One-Way, InformaCast®                           | VIP-412A-DF-IC | 31     |        |
| 4-Digits IP Talkback, InformaCast®                       | VIP-432A-DF-IC | 31     |        |
| <b>Backboxes</b>   |                |        |        |
| <b>Surface Mount</b>                                     | VB-S20         | 31     |        |
| <b>Recessed Mount</b>                                    | VB-R19         | 31     |        |
| <b>Angled Mount</b>                                      | VB-A21         | 31     |        |
| <b>SPEAKERS &amp; CLOCK SPEAKER ASSEMBLIES</b>           |                |        |        |
| <b>8-Inch Speaker Assemblies</b>                         |                |        |        |
| 24V Speaker  | VSA-1020C      | -1, 32 |        |
| 45 Ohm Speaker   | V-936418       | 0, 32  |        |
| 25/70 Volt Speaker                                       | V-936400       | 0, 32  |        |
| <b>Faceplates</b>  |                |        |        |
| Square Grille (Round Hole Pattern)                       | V-936480       | 32     |        |
| Vandal-Resistant Faceplate Gray, -CC                     | V-9808         | 32     |        |
| Vandal-Resistant Faceplate & Enclosure Gray, -CC         | V-9807         | 32     |        |
| <b>Backboxes for V-936480</b>                            |                |        |        |
| Angled   | VB-A13         | 32     |        |
| Recessed   | VB-R12         | 32     |        |
| Surface  | VB-S11         | 32     |        |
| <b>Clock Speaker Faceplates</b>                          |                |        |        |
| Analog Faceplate for 12-Inch Clock & 8-Inch Speaker      | V-CSB12S       | 32     |        |
| Digital Faceplate for 2.5-Inch Clock & 8-Inch Speaker    | V-CSB25        | 32     |        |
| <b>Backboxes for Clock/Speakers Faceplates</b>           |                |        |        |
| Surface  | VB-S20         | 32     |        |
| Recessed   | VB-R19         | 32     |        |
| Angled   | VB-A21         | 32     |        |

# Index

| Part #                    | Page # | Part #               | Page # | Part #              | Page #   | Part #       | Page # |
|---------------------------|--------|----------------------|--------|---------------------|----------|--------------|--------|
| V-400                     | 23     | V-1072A-ST           | 21     | V-2976              | 22       | V-9933A      | 22     |
| V-420                     | 23     | V-1072B-BRASS        | 21     | V-2991-W            | 22       | V-9934       | 22     |
| V-450                     | 23     | V-1072B-ST           | 21     | V-2992-W            | 22       | V-9936A      | 25     |
| V-762 -BK, -GY, -W        | 14     | V-1073               | 21     | V-2994-W            | 23       | V-9939C      | 23     |
| V-763 -BK, -GY, -W        | 14     | V-1074               | 21     | V-2995-W            | 22       | V-9940       | 8      |
| V-764 -BK, -GY, -W        | 14     | V-1080 -BGE, -GY, -W | 19     | V-5335700           | 8        | V-9941A      | 8      |
| V-1001                    | 12     | V-1090 -BGE, -GY, -W | 19     | V-5580041B          | 25       | V-9945A      | 25     |
| V-1010C -CC               | 11     | V-1092               | 22     | V-6120              | 24       | V-9955       | 24     |
| V-1013B -BK, -W, -CC      | 14     | V-1092B              | 22     | V-9010-W -CC        | 12       | V-9957       | 24     |
| V-1013B-WW                | 14     | V-1093BK             | 12     | V-9022A-2 -CC       | 10       | V-9964       | 24     |
| V-1014B -BK, -W, -CC      | 14     | V-1094A              | 23     | V-9022-EC -CC       | 10       | V-9970       | 8      |
| V-1015B -BK, -GY, -W, -CC | 12     | V-1094B              | 23     | V-9021 -CC          | 10       | V-9983-W     | 24     |
| V-1015B-WW                | 12     | V-1095               | 23     | V-9028 -CC          | 10       | V-9984-W     | 24     |
| V-1016-BK                 | 16     | V-1096               | 23     | V-9062 -CC          | 10       | V-9985-W     | 24     |
| V-1016-W                  | 16     | V-1097               | 22     | V-9320              | 22       | V-9988       | 24     |
| V-1020C -CC               | 11     | V-1220 -CC           | 11     | V-936400            | 32       | V-9989       | 24     |
| V-1022C                   | 16     | V-1222               | 16     | V-936418            | 32       | V-A11012B    | 30     |
| V-1023C                   | 16     | V-1420 -CC           | 13     | V-936480            | 32       | V-A11016B    | 30     |
| V-1026C                   | 16     | V-1422 -CC           | 13     | V-9422 -CC          | 22       | V-A2412B     | 30     |
| V-1026C-W                 | 16     | V-1440 -BK, -W, -CC  | 13     | V-9804              | 13,19,27 | V-A2416B     | 30     |
| V-1030C                   | 18     | V-1450 -CC           | 13     | V-9805              | 19       | V-AW12B      | 30     |
| V-1030C-GY                | 18     | V-1920C-CC           | 11     | V-9806              | 19       | V-AW12B-MD   | 30     |
| V-1030M                   | 18     | V-1921 -CC           | 11, 15 | V-9807              | 32       | V-AW12BLP    | 30     |
| V-1036C                   | 18     | V-1961 -CC           | 11, 15 | V-9808              | 32       | V-AW16B      | 30     |
| V-1036C-GY                | 18     | V-2000A              | 8      | V-9809              | 19       | V-AW16BLP    | 30     |
| V-1036M                   | 18     | V-2001A              | 8      | V-9815 -BR, -W, -CC | 19       | V-BDM12-S    | 31     |
| V-1038                    | 18     | V-2001A-E            | 8      | V-9816M             | 13       | V-BDM16-S    | 31     |
| V-1039A                   | 18     | V-2003A              | 8      | V-9830 -BR, -W, -CC | 19       | V-C6124P     | 27     |
| V-1040                    | 12     | V-2003A-E            | 8      | V-9852 -CC          | 17       | V-C806PK -CC | 27     |
| V-1042 -BK, -GY, -W, -CC  | 14     | V-2003AHF            | 8      | V-9871 -CC          | 17       | V-CIO        | 26     |
| V-1046 -BK, -CC           | 14     | V-2003AHF-E          | 8      | V-9880 -CC          | 17       | V-CLK        | 27     |
| V-1048C                   | 18     | V-2006A              | 8      | V-9885 -CC          | 17       | V-CLK2924    | 26     |
| V-1048C-GY                | 18     | V-2006A-E            | 8      | V-9890 -CC          | 17       | V-CPU4       | 26     |
| V-1048M                   | 18     | V-2006AHF            | 8      | V-9904M-5           | 11       | V-CSB12S     | 32     |
| V-1050C                   | 18     | V-2006AHF-E          | 8      | V-9908              | 23       | V-CSB25      | 32     |
| V-1052C -CC               | 15     | V-2900               | 21     | V-9910-BK           | 21       | V-CTLA-2 -CC | 27     |
| V-1054 -CC                | 15     | V-2901A              | 21     | V-9910-YEL          | 21       | V-CTSQPK -CC | 11,27  |
| V-1055 -CC                | 15     | V-2904               | 21     | V-9912M-10          | 11       | V-D2425B     | 30     |
| V-1060A -CC               | 11     | V-2924A              | 26     | V-9912P-12          | 11       | V-D2440B     | 30     |
| V-1061-BK                 | 16     | V-2925A              | 26     | V-9914M-5           | 11       | V-DCH        | 31     |
| V-1061-W                  | 16     | V-2926               | 26     | V-9915M-5           | 11,30    | V-DCPI       | 31     |
| V-1063A                   | 16     | V-2927               | 26     | V-9916M             | 11       | V-DMKIT      | 31     |
| V-1069A                   | 18     | V-2928               | 26     | V-9923B             | 25       | V-DSP        | 27     |
| V-1070                    | 12     | V-2970               | 22,27  | V-9924C             | 25       | V-DW11025B   | 30     |
| V-1071 -CC                | 15     | V-2971               | 22     | V-9925A             | 25       | V-DW11040B   | 30     |
| V-1072A-BRASS             | 21     | V-2972PK             | 22,27  | V-9927A             | 25       | V-GPS-TX     | 31     |

| Part #     | Page #      | Part #                | Page # | Part #                     | Page # | Part #      | Page # |
|------------|-------------|-----------------------|--------|----------------------------|--------|-------------|--------|
| V-GPSA     | 31          | VB-S23                | 31, 32 | VIP-422A                   | 10     | VIP-9896    | 29     |
| V-LPT      | 27          | VBB-1424              | 20     | VIP-422A-IC                | 10     | VIP-999     | 24     |
| V-MCRK     | 27          | VC-1060A -CC          | 27     | VIP-426A-D -CC             | 31     | VIP-A12A    | 30     |
| V-MWRK     | 27          | VC-1061-BK            | 27     | VIP-428A -CC               | 11, 15 | VIP-A12ADS  | 30     |
| V-PDP      | 27          | VC-1061-W             | 27     | VIP-428A-IC -CC            | 11, 15 | VIP-A16A    | 30     |
| V-PR24     | 26          | VC-1062A              | 27     | VIP-429A-A -CC             | 31     | VIP-A16ADS  | 30     |
| V-PR48     | 26          | VC-1090 -BGE, -GY, -W | 27     | VIP-429A-D -CC             | 31     | VIP-D425A   | 30     |
| V-PR72     | 26          | VC-9062 -CC           | 27     | VIP-429A-D-IC -CC          | 31     | VIP-D425ADS | 30     |
| V-PR96     | 26          | VC40R-4               | 27     | VIP-430A -CC               | 15     | VIP-D440A   | 30     |
| V-PW24     | 26          | VC40R-8T              | 27     | VIP-430A-IC -CC            | 15     | VIP-D440ADS | 30     |
| V-PW48     | 26          | VC40R-9T              | 27     | VIP-431A-DS -CC            | 31     | VIP-D625A   | 30     |
| V-RDP      | 27          | VC40R-16T             | 27     | VIP-431A-DS-IC -CC         | 31     | VIP-D625ADS | 30     |
| V-SER      | 27          | VE9811                | 28     | VIP-432A-DF -CC            | 31     | VIP-D640A   | 30     |
| V-SLC      | 27          | VE9811-IC             | 28     | VIP-432A-DF-IC -CC         | 31     | VIP-D640ADS | 30     |
| V-STX      | 26          | VE9870A               | 29     | VIP-480AL -BGE, -GY, -W    | 19     | VL530A      | 25     |
| V-SMR12A   | 31          | VIP-120A -CC          | 11     | VIP-480AL-IC -BGE, -GY, -W | 19     | VL530A-IC   | 25     |
| V-SMR16A   | 31          | VIP-120A-IC -CC       | 11     | VIP-490AL -BGE, -GY, -W    | 19     | VL550A      | 25     |
| V-TBAR     | 10, 13, 27  | VIP-130AL-BGE         | 18     | VIP-490AL-IC -BGE, -GY, -W | 19     | VL550A-IC   | 25     |
| V-TCM      | 26          | VIP-130AL-BGE-IC      | 18     | VIP-580A -CC               | 17     | VL550AF     | 25     |
| V-TR24     | 26          | VIP-130AL-GY          | 18     | VIP-580A-IC -CC            | 17     | VL550AF-IC  | 25     |
| V-TR48     | 26          | VIP-130AL-GY-IC       | 18     | VIP-581A -CC               | 17     | VM-SRLY     | 21     |
| V-TR72     | 26          | VIP-130AL-M           | 18     | VIP-581A-IC -CC            | 17     | VMT-1       | 23     |
| V-TR96     | 26          | VIP-130AL-M-IC        | 18     | VIP-801A                   | 9      | VMT-2       | 23     |
| V-TW24     | 26          | VIP-140A -CC          | 12     | VIP-801A-IC                | 9      | VP-1124D    | 20     |
| V-TW48     | 26          | VIP-148AL-BGE         | 18     | VIP-802A                   | 9      | VP-1124D-UK | 20     |
| V-URI      | 26          | VIP-148AL-BGE-IC      | 18     | VIP-804A                   | 9      | VP-12124    | 20     |
| V-VCU      | 31          | VIP-148AL-GY          | 18     | VIP-811A                   | 9      | VP-2124D    | 20     |
| V-WGACLK   | 31          | VIP-148AL-GY-IC       | 18     | VIP-812A                   | 9      | VP-2124D-EC | 20     |
| V-WGD4     | 31          | VIP-148AL-M           | 18     | VIP-814A                   | 9      | VP-2124D-UK | 20     |
| V-WGFLEX-2 | 19          | VIP-148AL-M-IC        | 18     | VIP-821A                   | 9      | VP-2148D    | 20     |
| V-WGHORN-2 | 18          | VIP-160A -CC          | 11     | VIP-822A                   | 9      | VP-324D     | 20, 21 |
| V-WGWALL-2 | 13,14,15,16 | VIP-160A-IC -CC       | 11     | VIP-824A                   | 9      | VP-412A     | 20     |
| V-WMB-12   | 31          | VIP-172AL-VRSS        | 21     | VIP-851-25                 | 9      | VP-4124D    | 20     |
| V-WMB-16   | 31          | VIP-172AL-BRASS       | 21     | VIP-851-70/100             | 9      | VP-4124D-EC | 20     |
| V-WMCA     | 31          | VIP-172AL-ST          | 21     | VIP-9815A -BR, -W, -CC     | 19     | VP-6124     | 20     |
| V-WMCRA    | 31          | VIP-176               | 21     | VIP-9815AL-IC -BR, -W, -CC | 19     | VP-6124-E   | 20     |
| V-WTGY -CC | 27          | VIP-201A              | 9      | VIP-9831A -BR, -W, -CC     | 19     | VP-6124-UPS | 20     |
| VB-A13     | 11, 15, 32  | VIP-204A              | 9      | VIP-9880A -CC              | 19     | VP-624D     | 20     |
| VB-A21     | 31, 32      | VIP-324D              | 20     | VIP-9880A-IC -CC           | 19     | VP-9202     | 20     |
| VB-A24     | 31, 32      | VIP-402A              | 10     | VIP-9894                   | 29     | VPB-260     | 20     |
| VB-R12     | 11, 15, 32  | VIP-402A-EC           | 10     | VIP-9894-IC                | 29     | VSA-1020C   | 32     |
| VB-R17-D   | 19, 32      | VIP-402A-IC           | 10     | VIP-9890AL-CB              | 29     |             |        |
| VB-R19     | 31, 32      | VIP-410A-IC -CC       | 15     | VIP-9890A-EM               | 29     |             |        |
| VB-R22     | 31, 32      | VIP-412A-DF-IC -CC    | 31     | VIP-9890AL-EM              | 29     |             |        |
| VB-S11     | 11,15, 32   | VIP-418A-IC -CC       | 11, 15 | VIP-9895                   | 29     |             |        |
| VB-S20     | 31, 32      | VIP-419A-D-IC -CC     | 31     | VIP-9895-IC                | 29     |             |        |

*The World's Leading Manufacturer of Integrated Paging Systems ...  
is celebrating over 35 years of fulfilling customer's needs.*

*Customer suggestions, experience and growth in new markets has  
helped define our line of paging products. Valcom's extensive array  
of paging products are engineered, built and supported in the USA.*

**We Can Help You Deliver ...  
... the Right Message  
... to the Right People  
... at the Right Time!**



### **VALCOM OFFERS**

- Pre-Sale Design Assistance
- Large System Site Surveys at No Cost
- Easy Product Availability
- Emergency 24/7 Technical Support at 1-800-VALCOM-1
- Informative Website at [www.valcom.com](http://www.valcom.com)

### **LITERATURE**

- Technical Documentation
- Product Installation Documents
- Marketing Sheets
- Industry Guides
- Application Briefs
- A & E Specs
- Site Survey Form

### **WHY CHOOSE VALCOM**

- Engineered, Built and Supported in the USA
- Excellent Industry Reputation
- Exceptional Customer Sales and Technical Support
- Products Designed for Structured Cabling
- Systems are Easy to Design, Install, Adjust and Use
- Highest Quality Products in the Industry